

Tips for Deep Learning

Recipe of Deep Learning

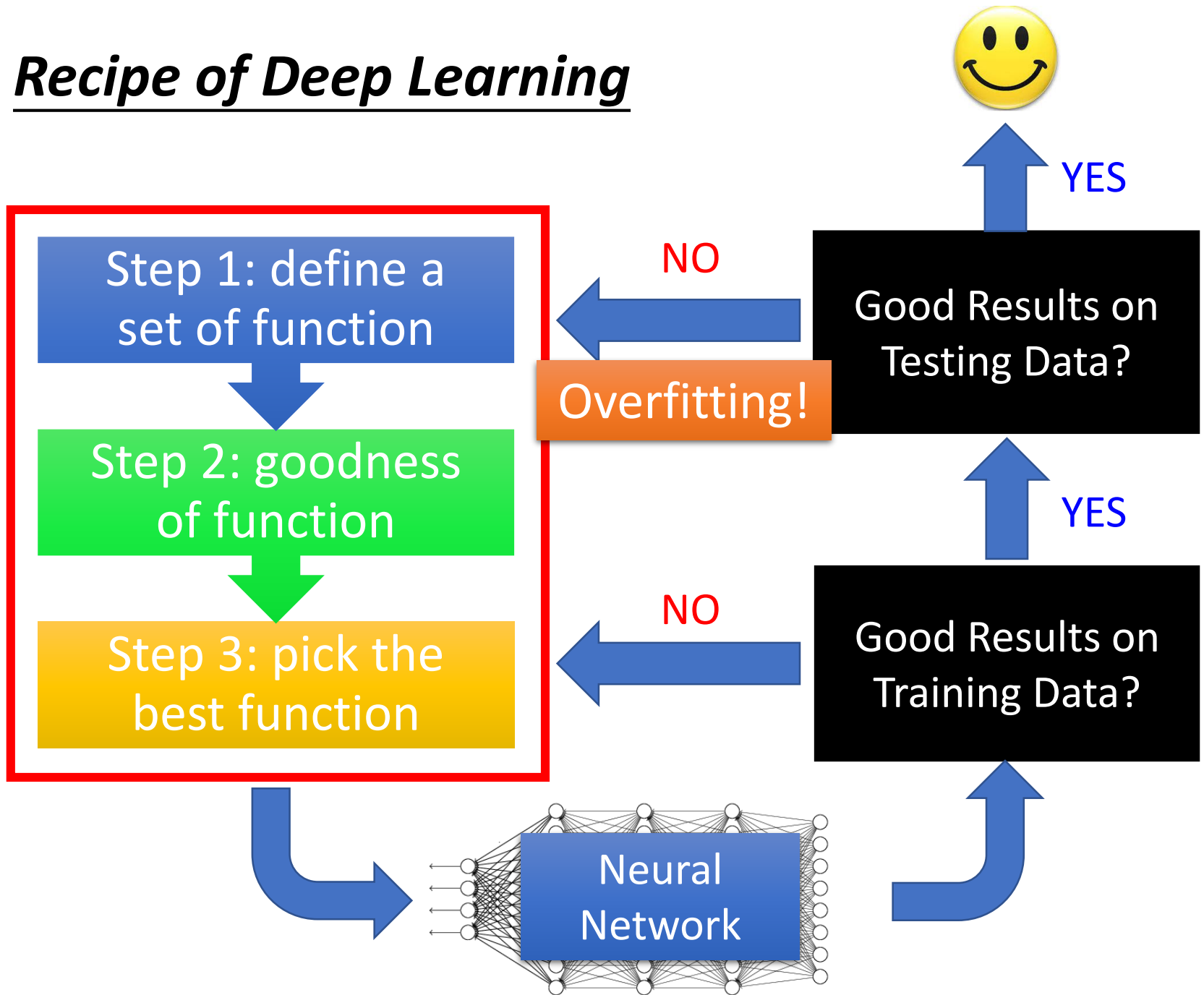

Do not always blame Overfitting

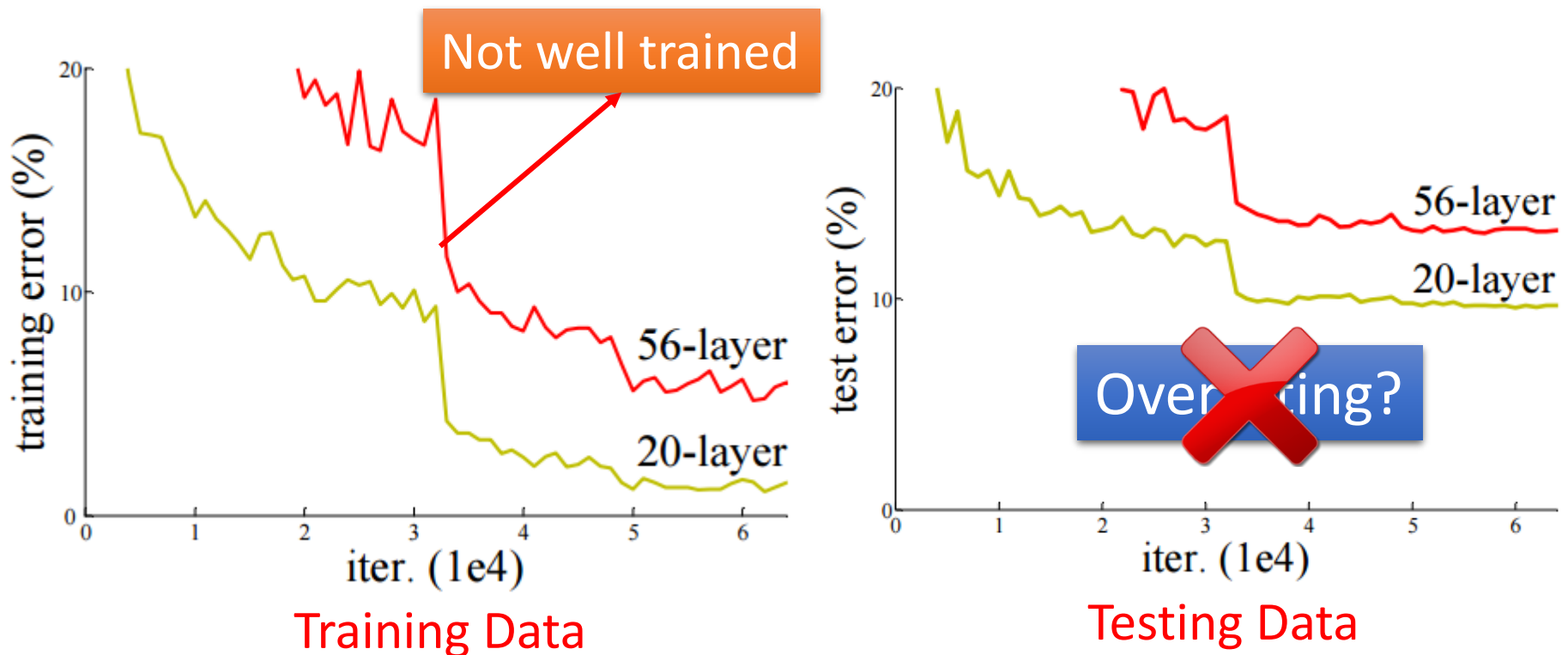

Deep Residual Learning for Image Recognition
<http://arxiv.org/abs/1512.03385>

Recipe of Deep Learning

Different approaches for different problems.

e.g. dropout for good results on testing data

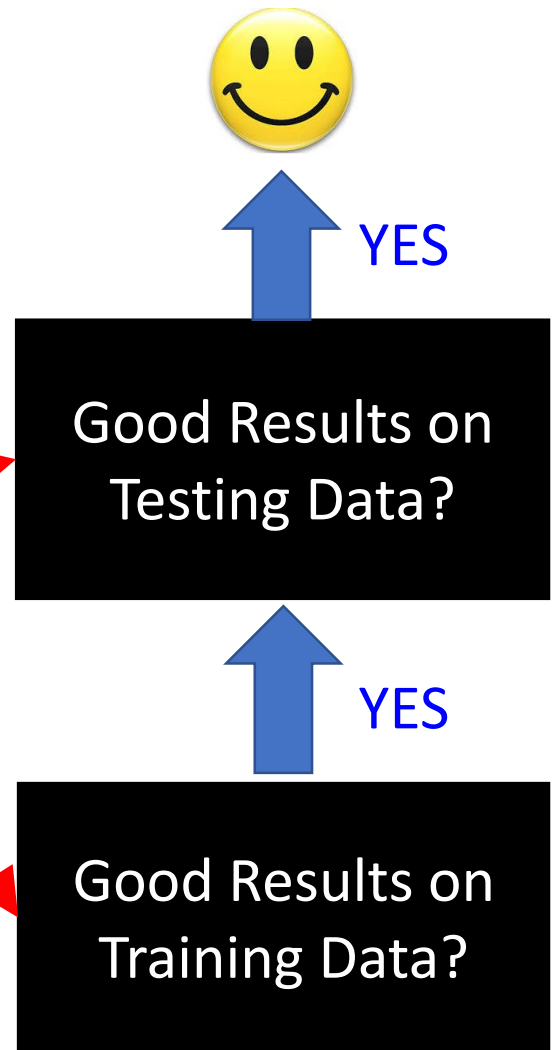
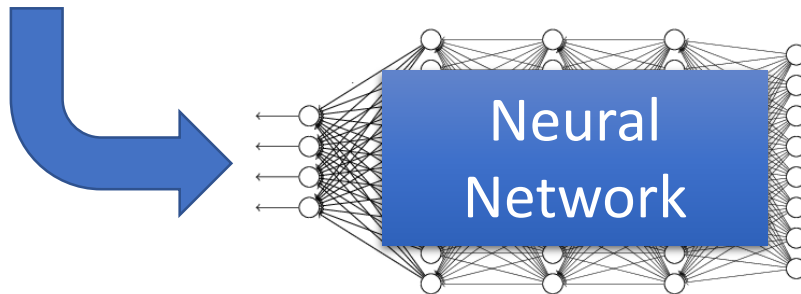

Recipe of Deep Learning

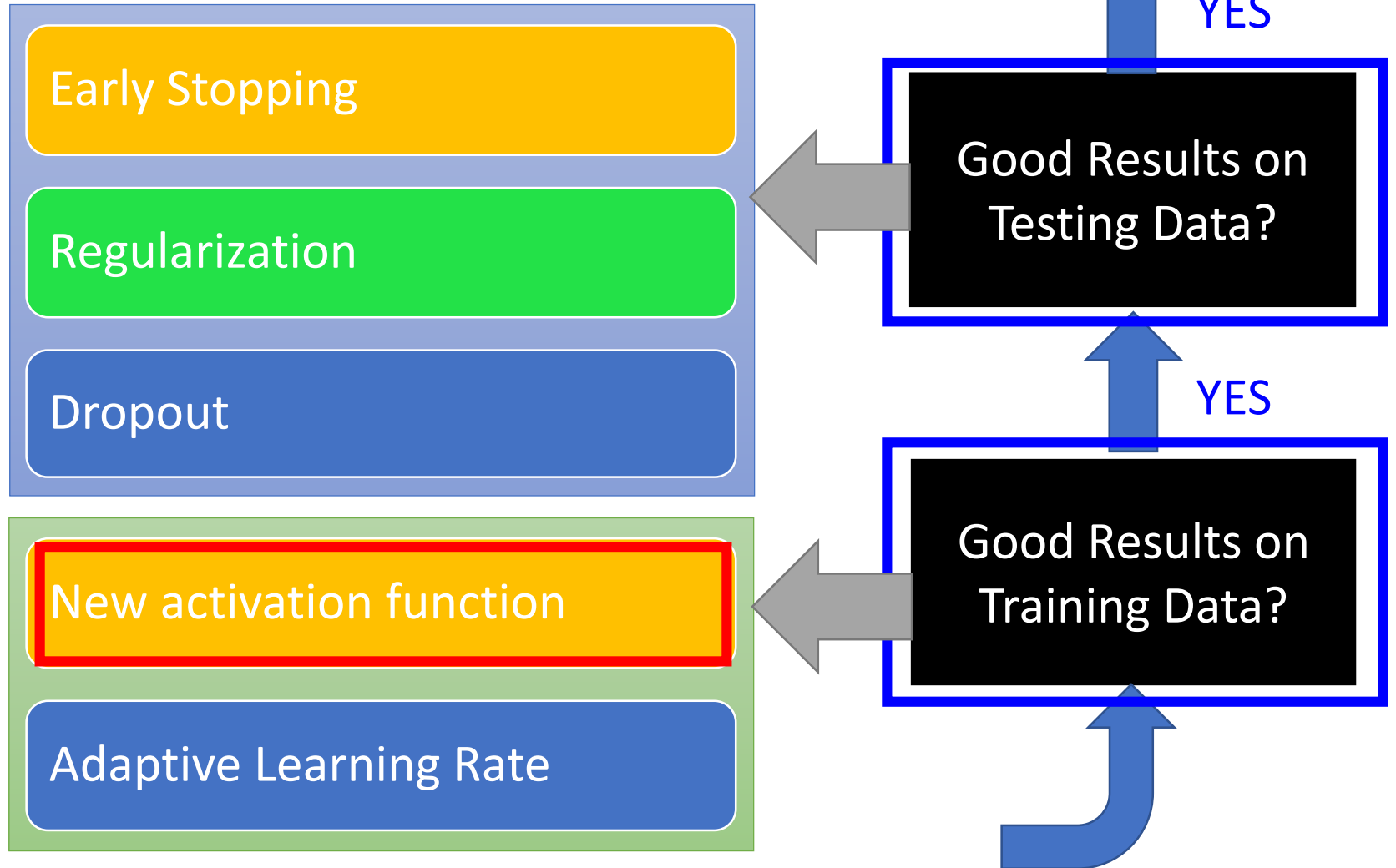

Hard to get the power of Deep ...

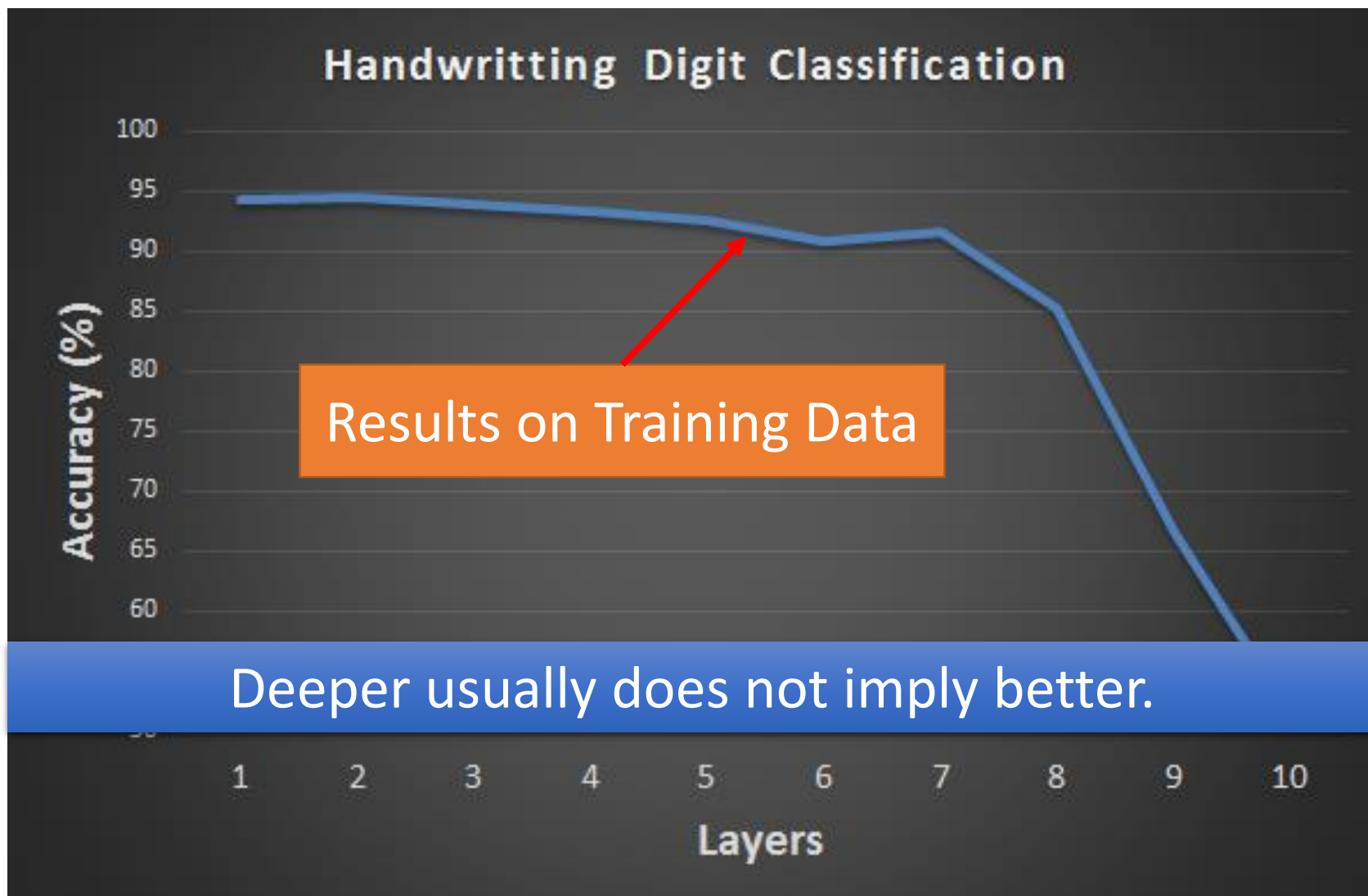

Vanishing Gradient Problem

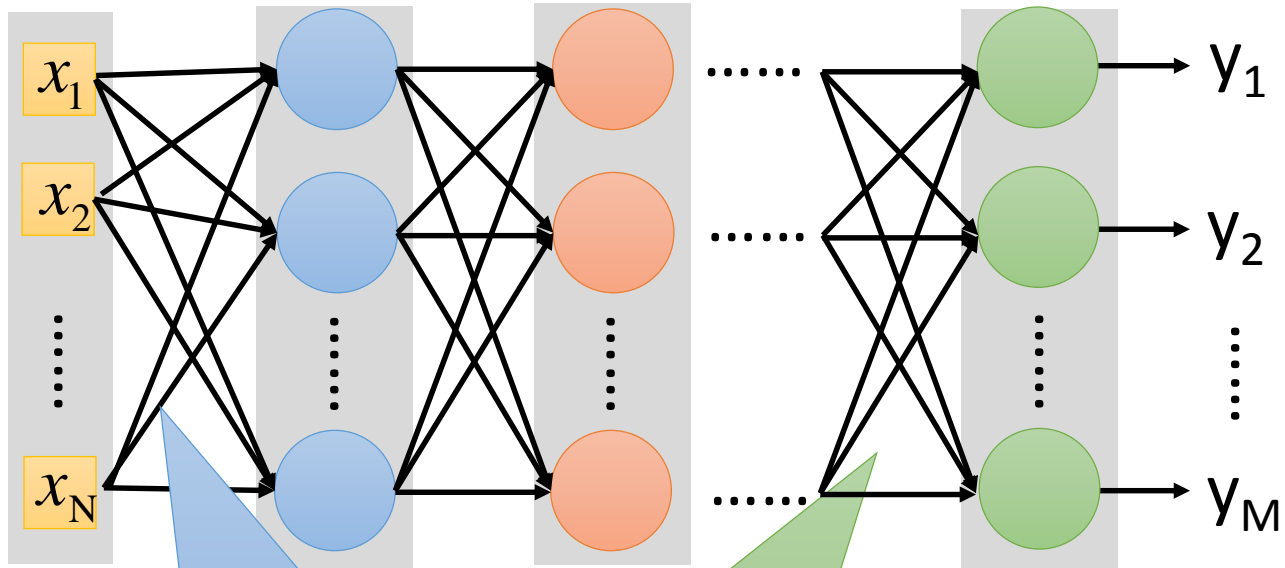

Smaller gradients

Learn very slow

Almost random

Larger gradients

Learn very fast

Already converge

based on random!?

Vanishing Gradient Problem

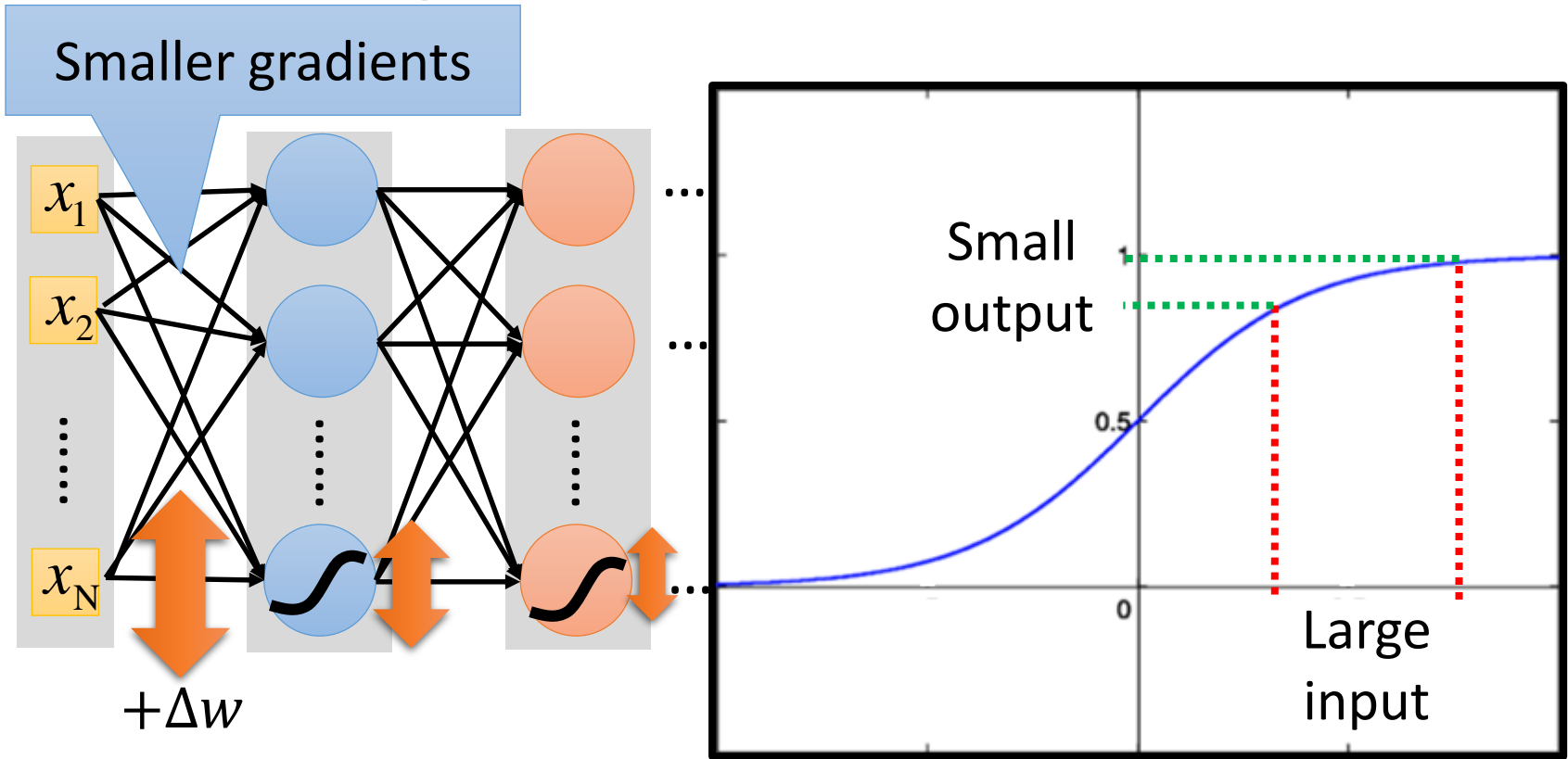

Intuitive way to compute the derivatives ...

$$\frac{\partial C}{\partial w} \stackrel{?}{=} \frac{\Delta C}{\Delta w}$$

ReLU

- Rectified Linear Unit (ReLU)

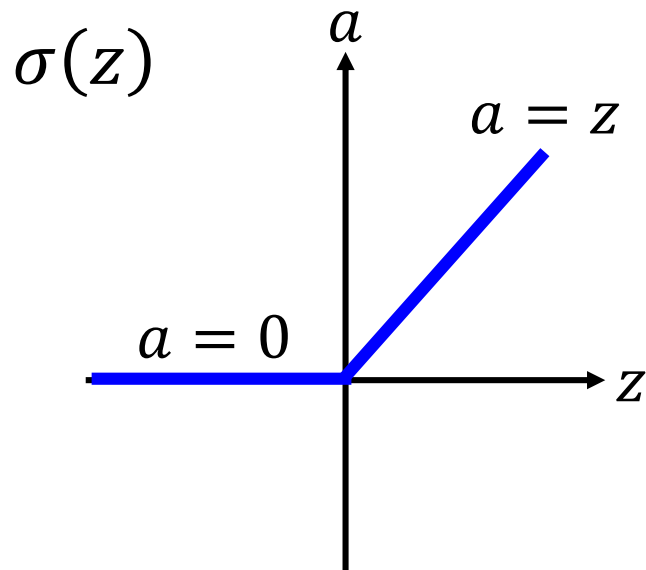

[Xavier Glorot, AISTATS'11]
[Andrew L. Maas, ICML'13]
[Kaiming He, arXiv'15]

Reason:

1. Fast to compute
2. Biological reason
3. Infinite sigmoid with different biases
4. Vanishing gradient problem

ReLU

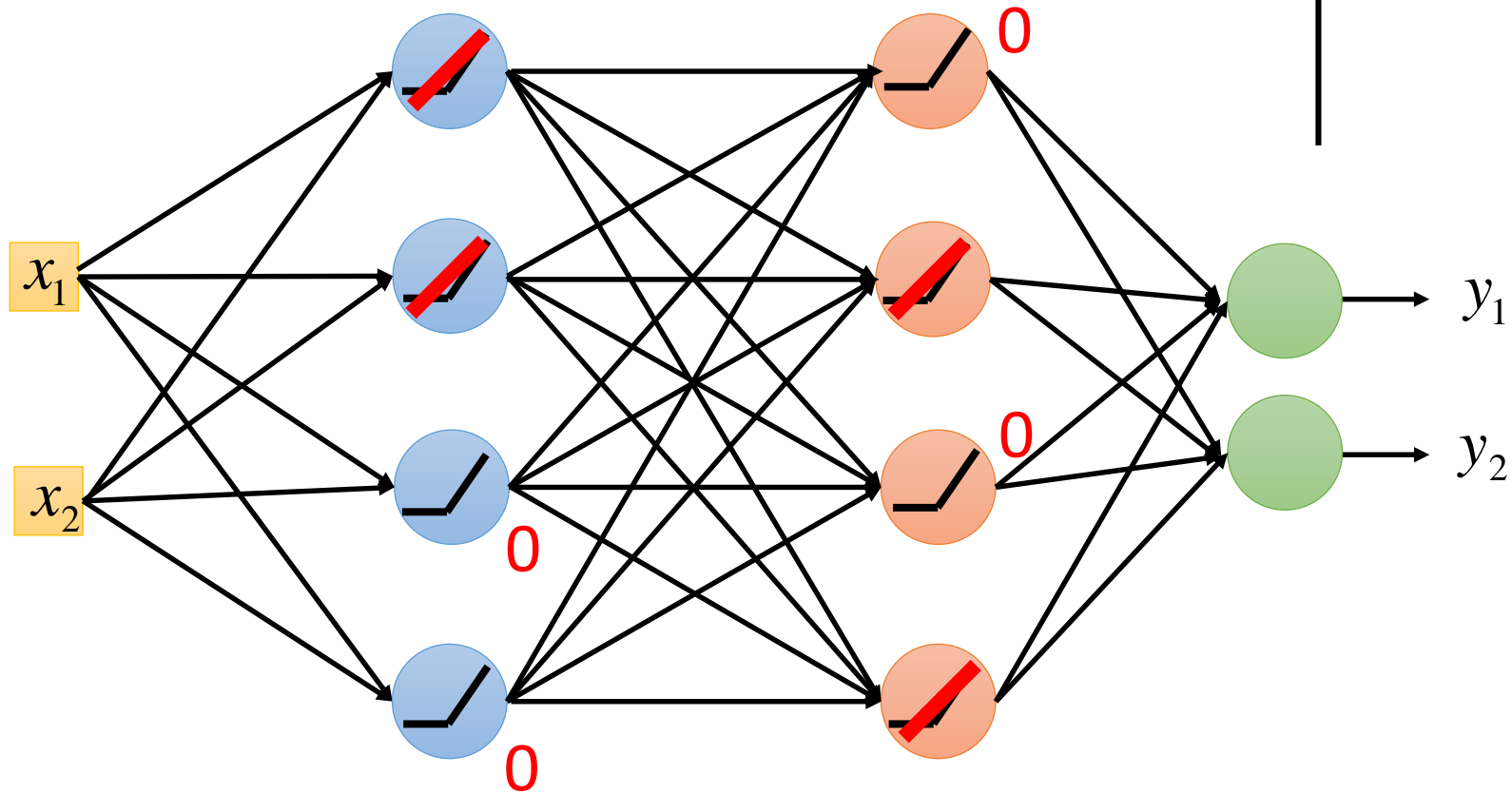
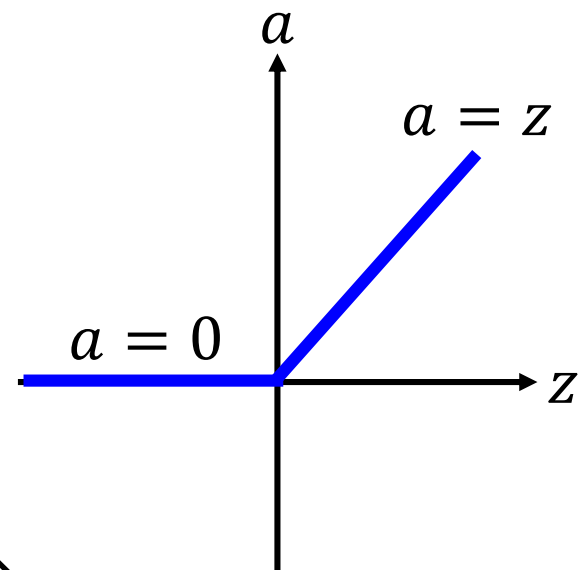

ReLU

A Thinner linear network

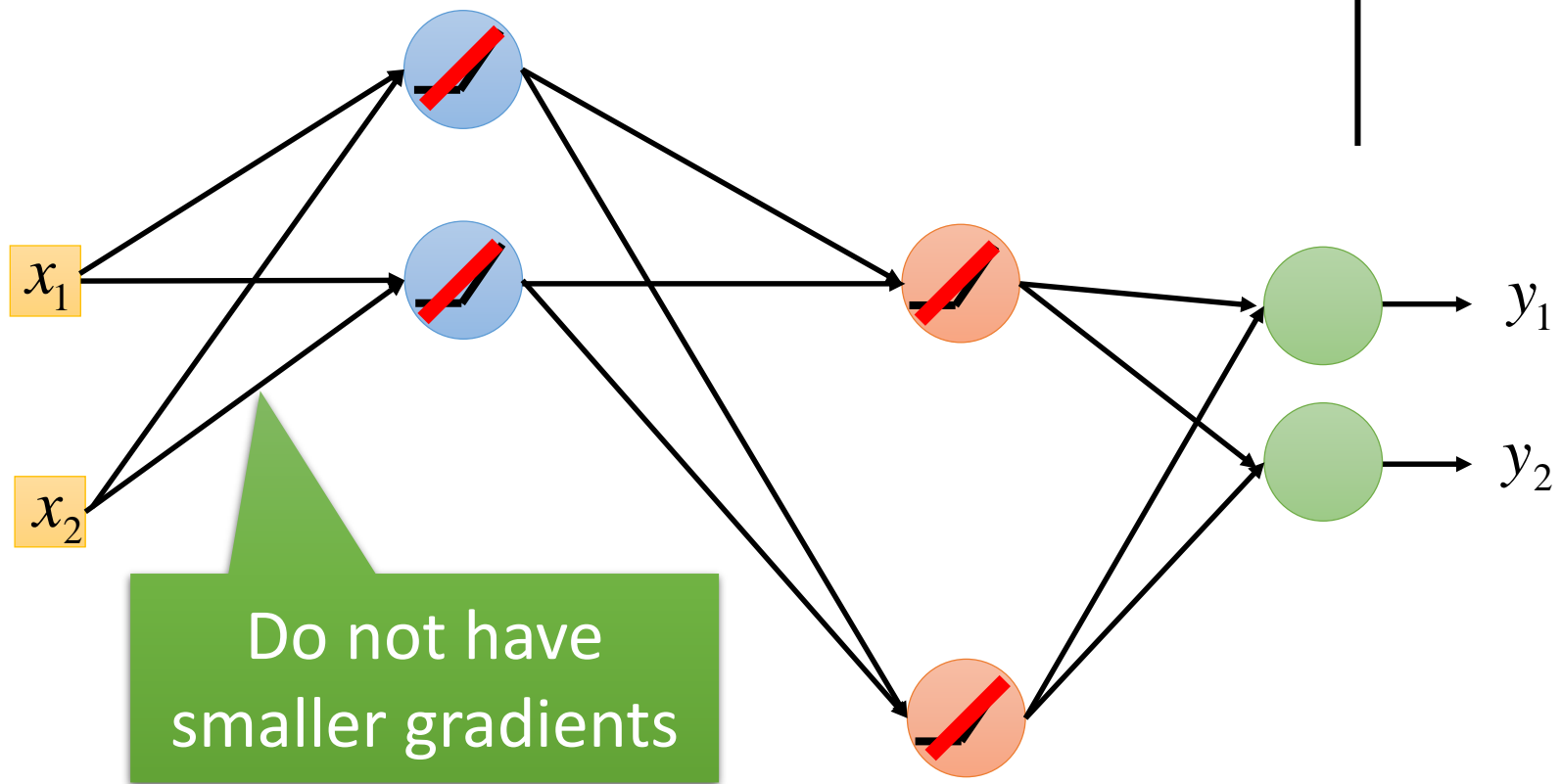
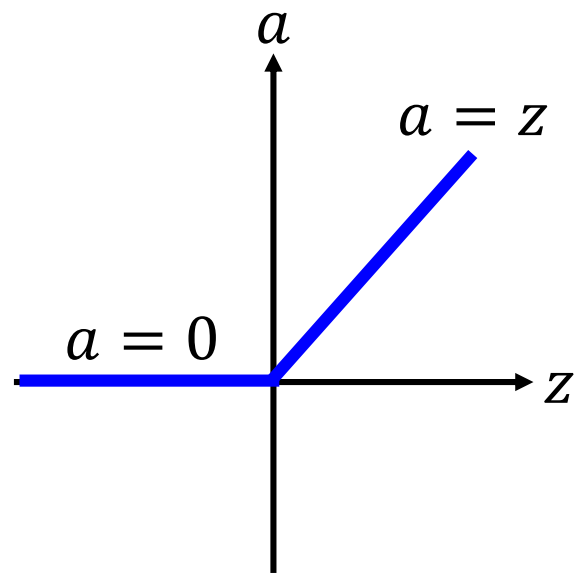

ReLU - variant

Leaky ReLU

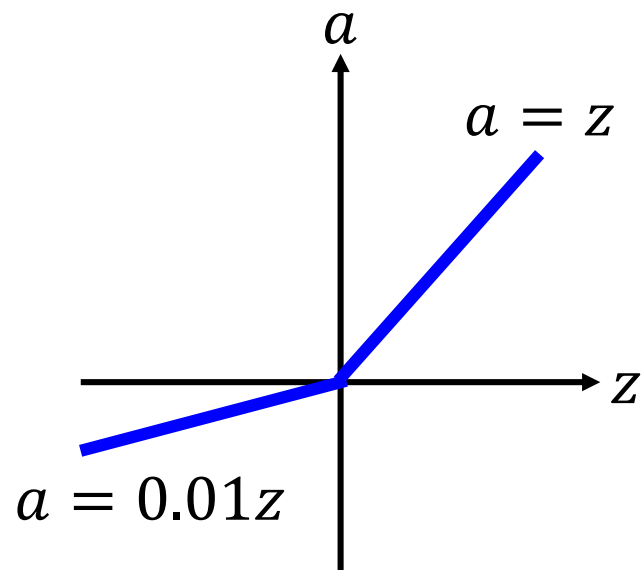

Parametric ReLU

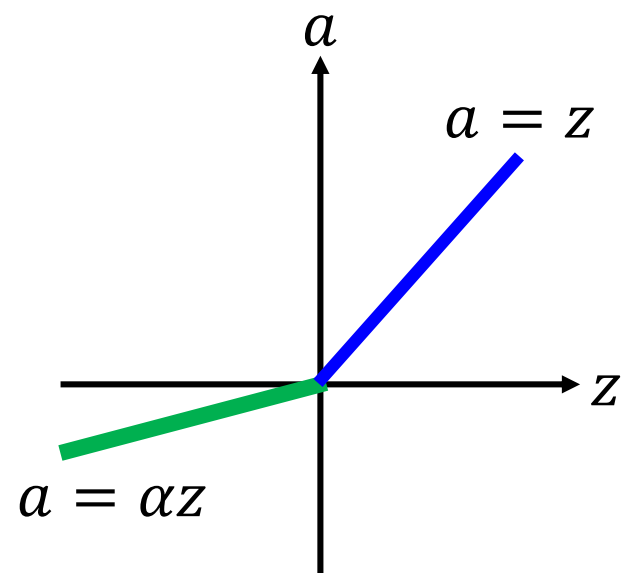

α also learned by
gradient descent

Maxout

ReLU is a special cases of Maxout

- Learnable activation function [Ian J. Goodfellow, ICML'13]

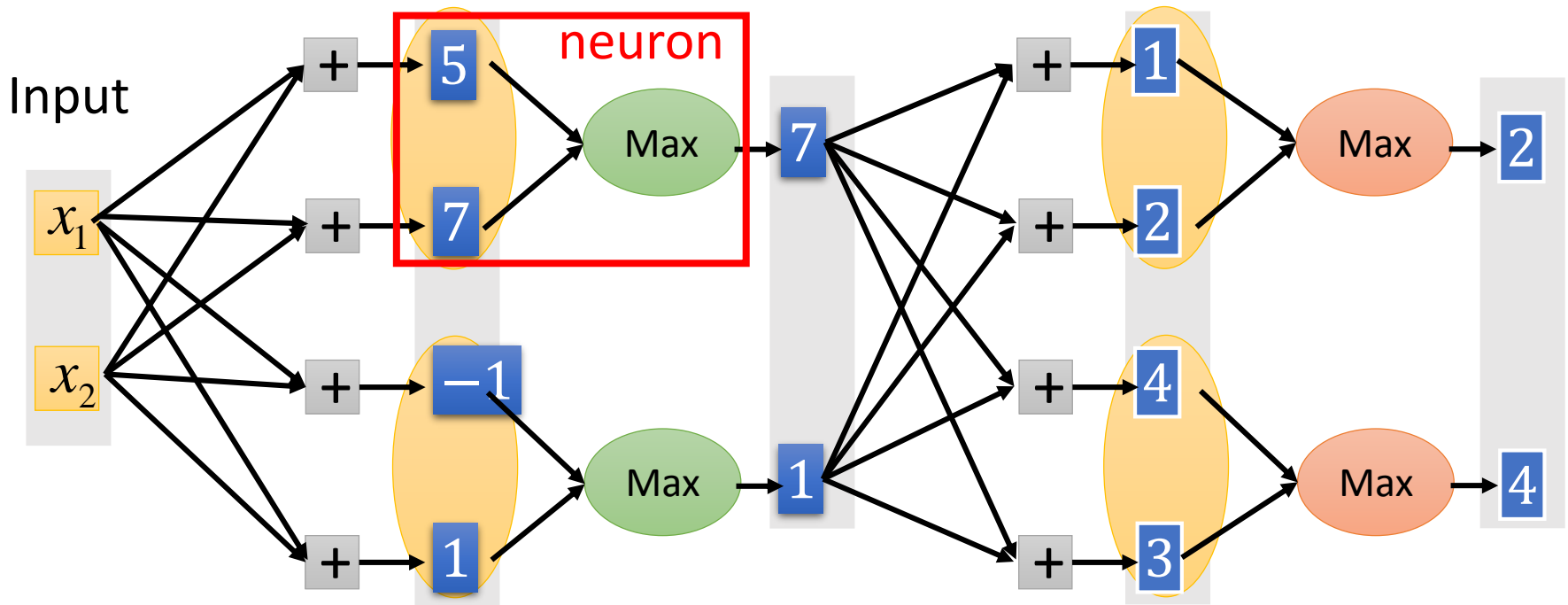

You can have more than 2 elements in a group.

Maxout

ReLU is a special cases of Maxout

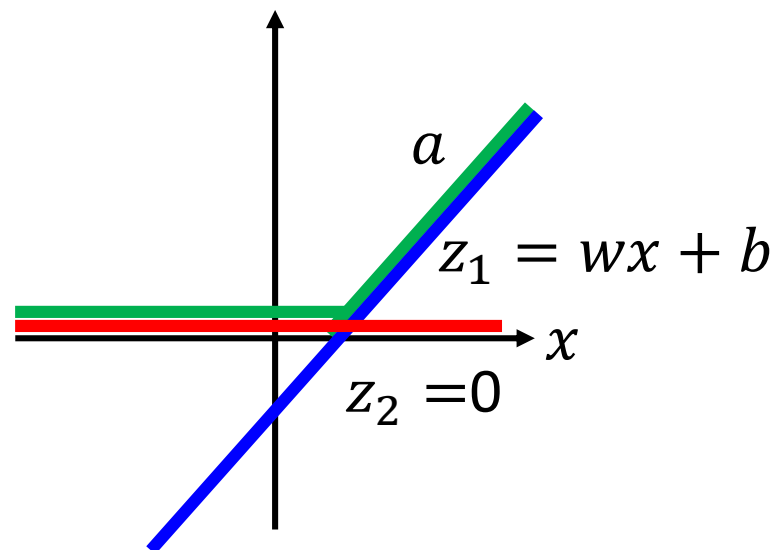
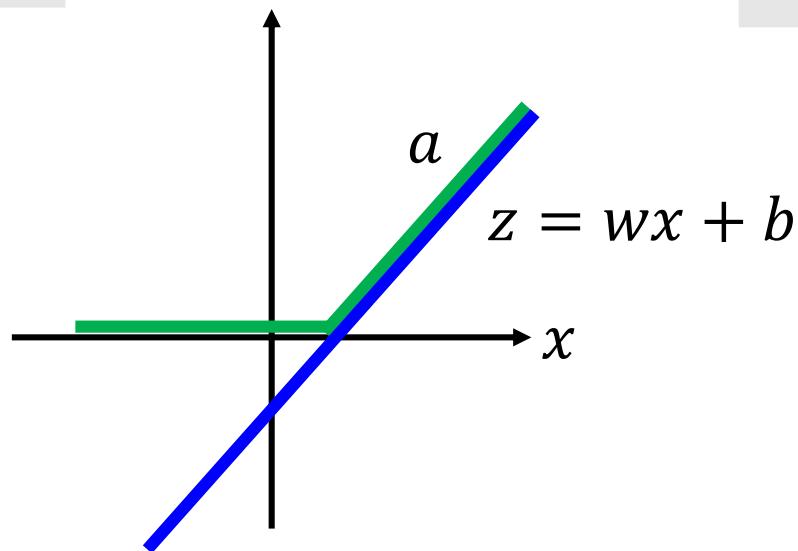
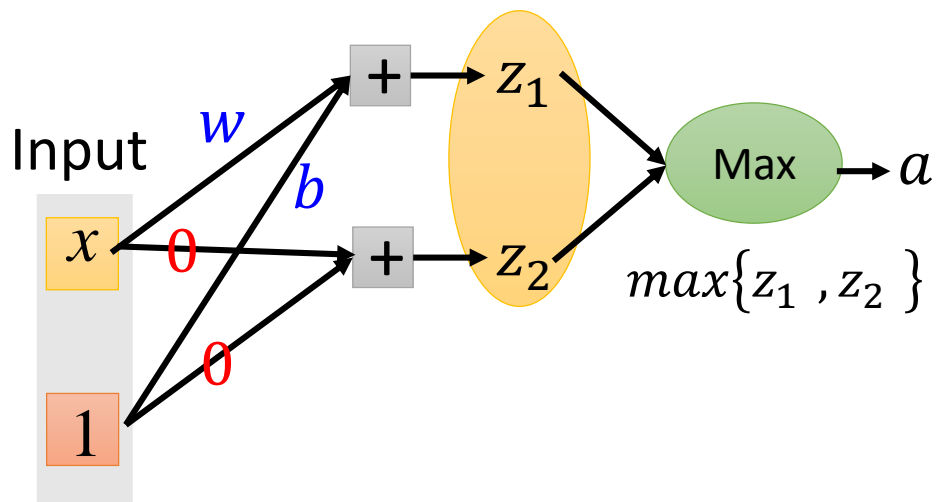
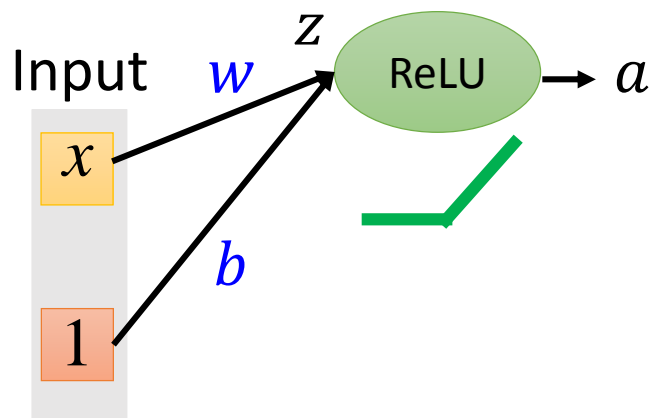

Maxout

More than ReLU

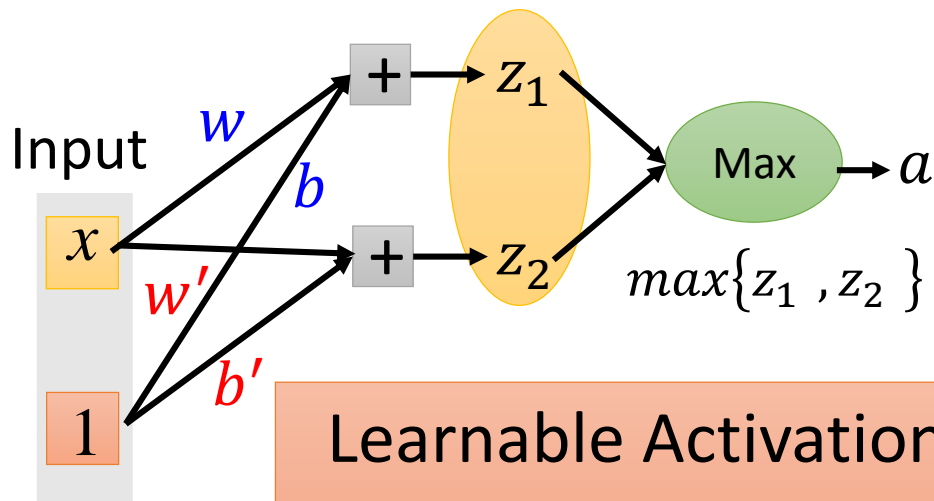
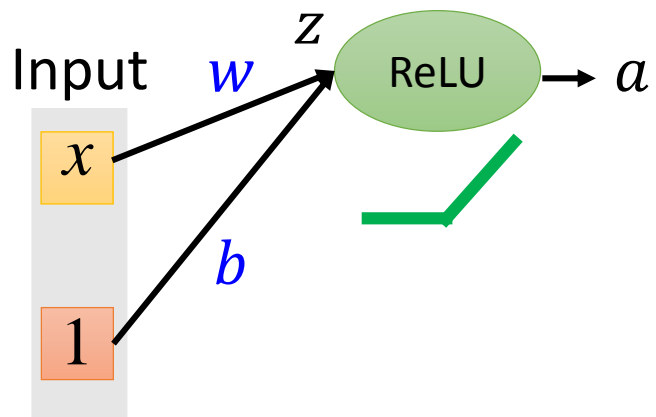

Learnable Activation Function

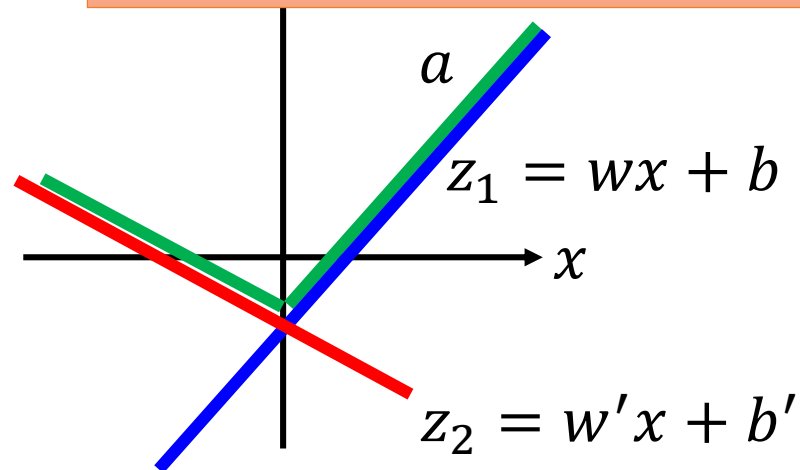
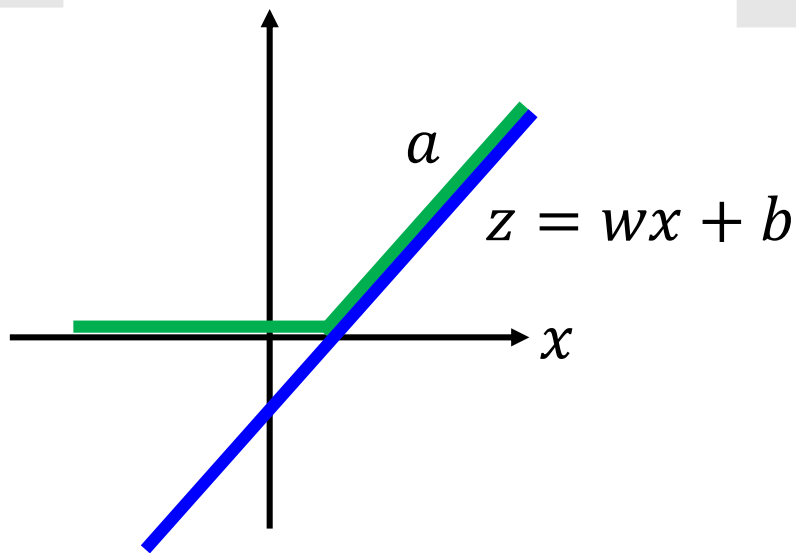

Maxout

- Learnable activation function [Ian J. Goodfellow, ICML'13]
 - Activation function in maxout network can be any piecewise linear convex function
 - How many pieces depending on how many elements in a group

2 elements in a group

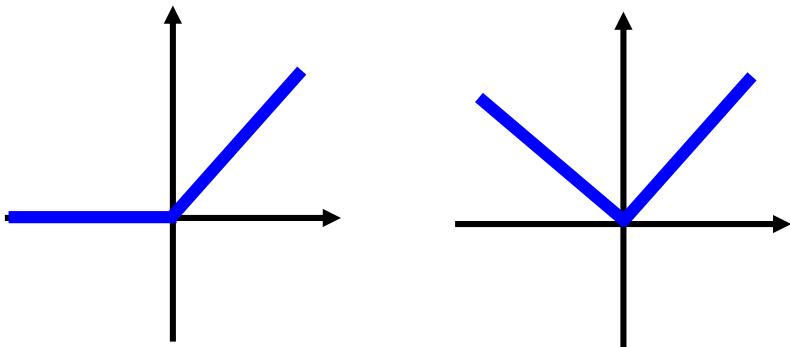

3 elements in a group

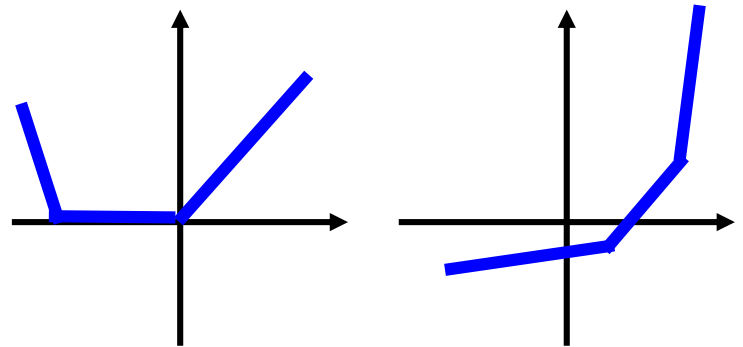

Maxout - Training

- Given a training data x , we know which z would be the max

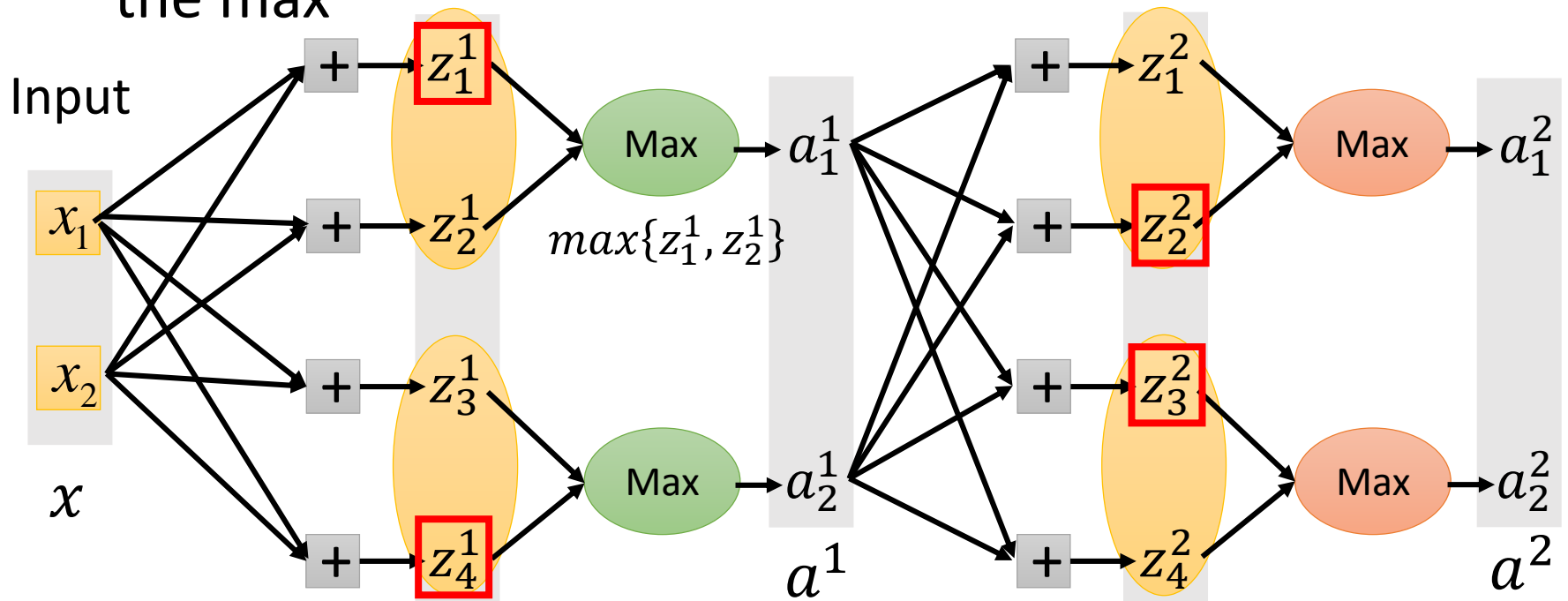

Maxout - Training

- Given a training data x , we know which z would be the max

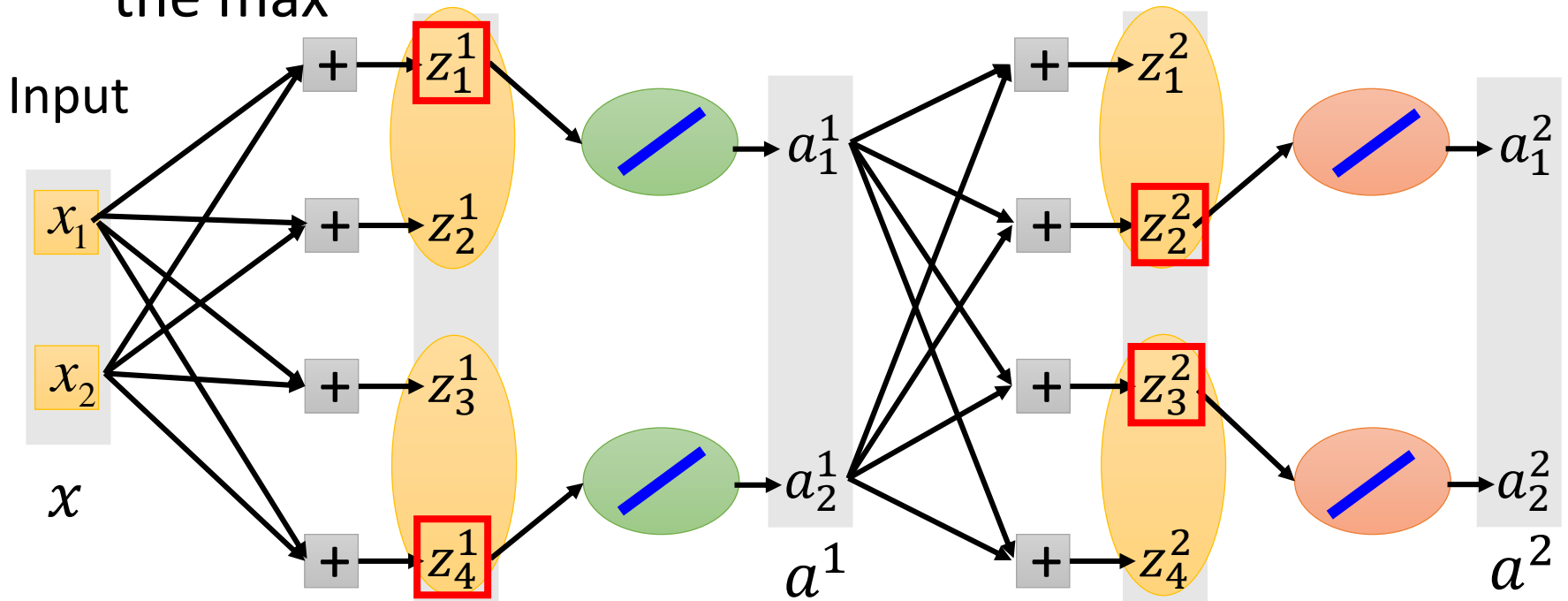

- Train this thin and linear network

Different thin and linear network for different examples

Recipe of Deep Learning

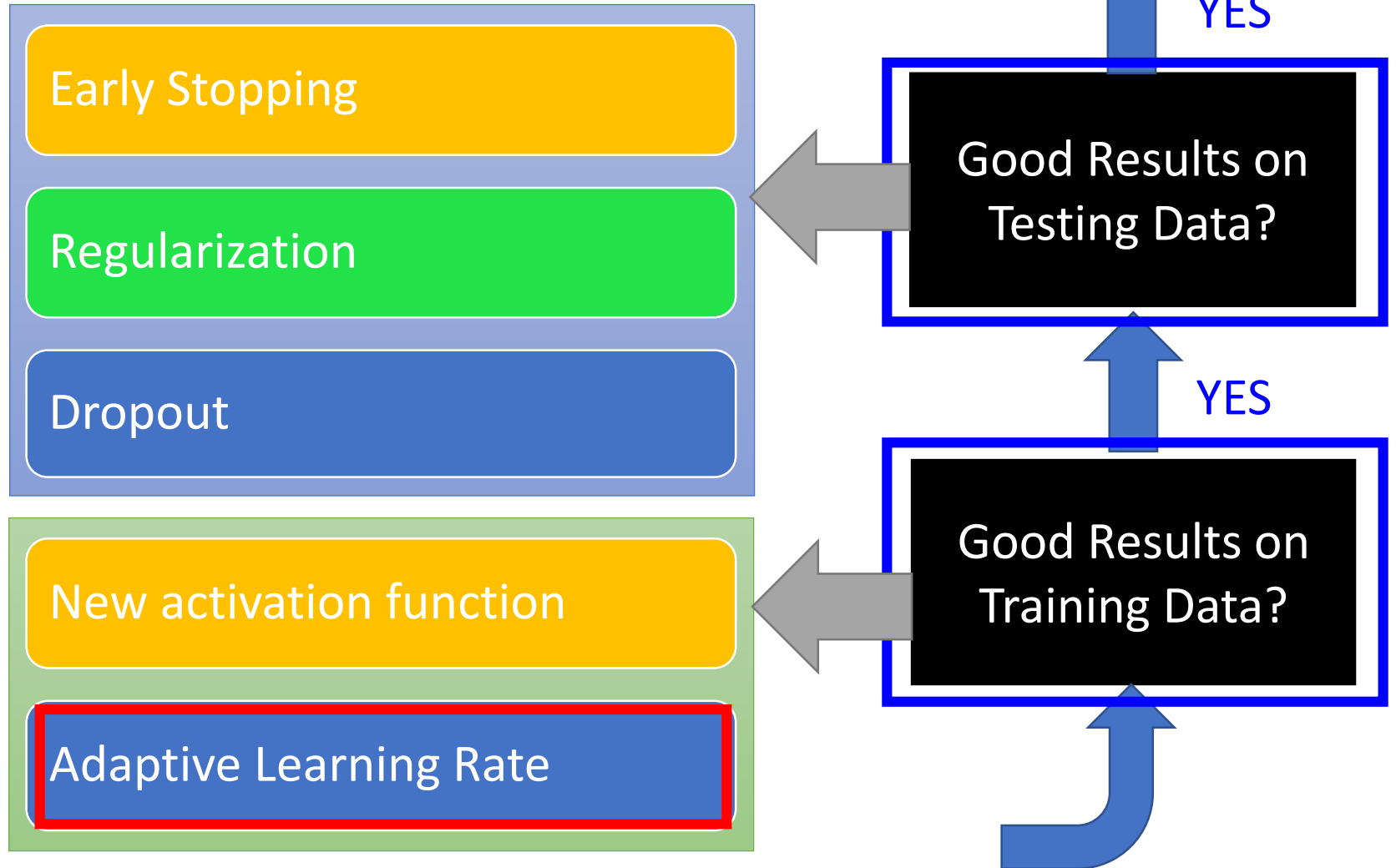

Review

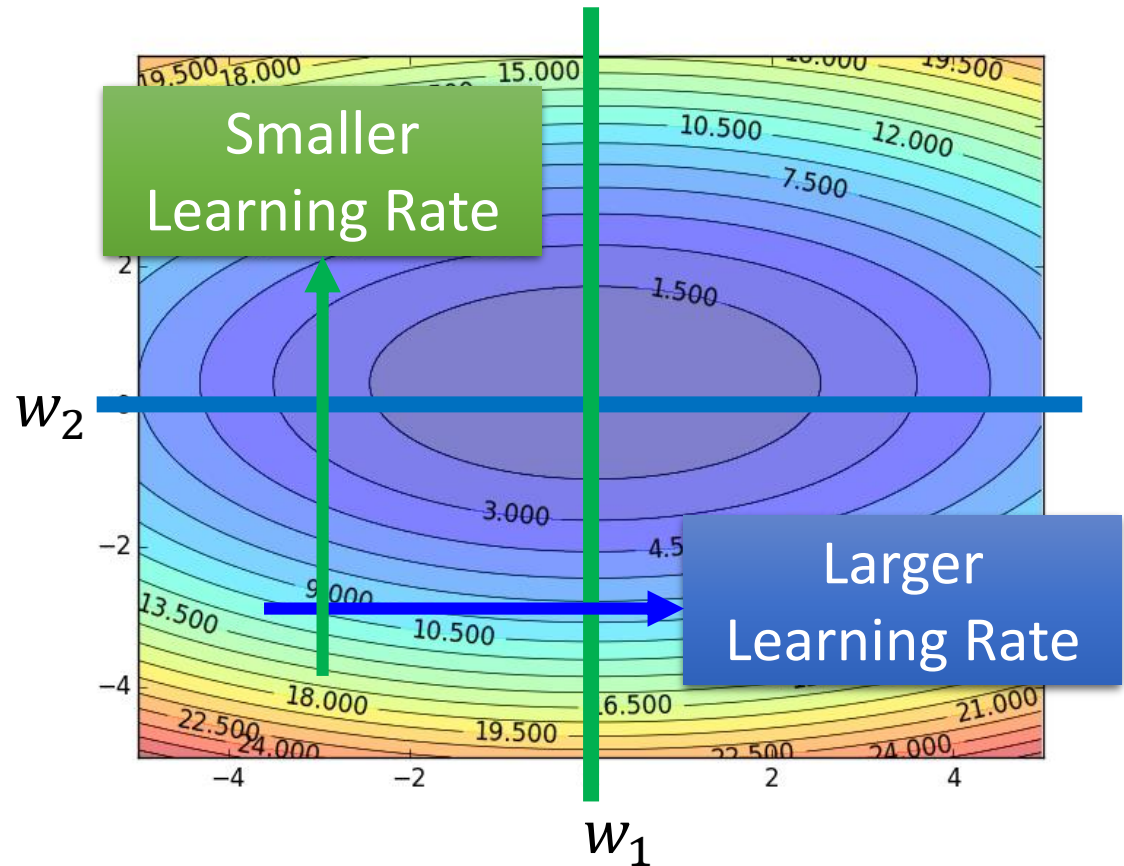

Adagrad

$$w^{t+1} \leftarrow w^t - \frac{\eta}{\sqrt{\sum_{i=0}^t (g^i)^2}} g^t$$

Use first derivative to estimate second derivative

RMSProp

Error Surface can be very complex when training NN.

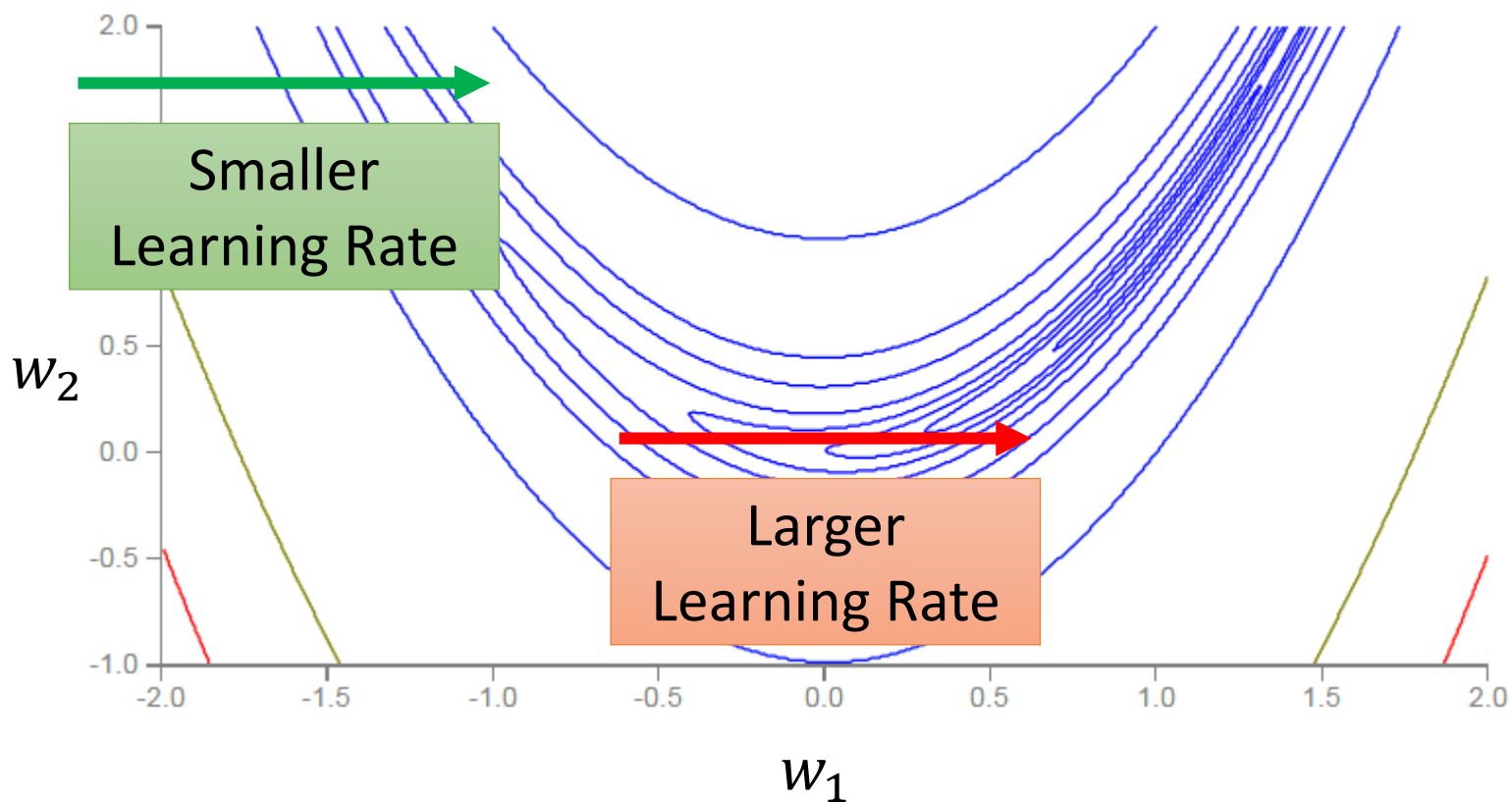

RMSProp

$$w^1 \leftarrow w^0 - \frac{\eta}{\sigma^0} g^0 \quad \sigma^0 = g^0$$

$$w^2 \leftarrow w^1 - \frac{\eta}{\sigma^1} g^1 \quad \sigma^1 = \sqrt{\alpha(\sigma^0)^2 + (1 - \alpha)(g^1)^2}$$

$$w^3 \leftarrow w^2 - \frac{\eta}{\sigma^2} g^2 \quad \sigma^2 = \sqrt{\alpha(\sigma^1)^2 + (1 - \alpha)(g^2)^2}$$

⋮

$$w^{t+1} \leftarrow w^t - \frac{\eta}{\sigma^t} g^t \quad \sigma^t = \sqrt{\alpha(\sigma^{t-1})^2 + (1 - \alpha)(g^t)^2}$$

Root Mean Square of the gradients
with previous gradients being decayed

Hard to find optimal network parameters

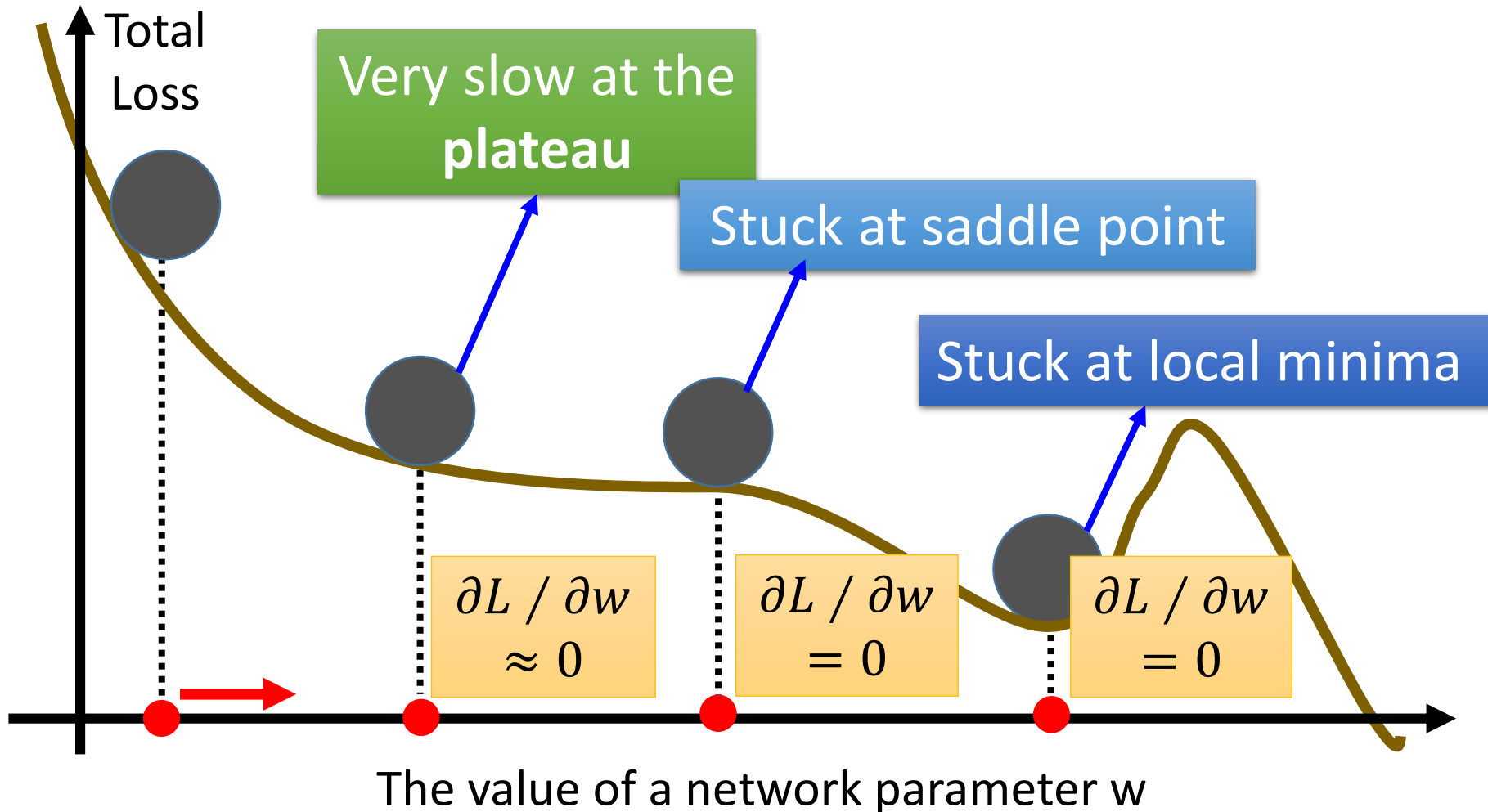

In physical world

- Momentum

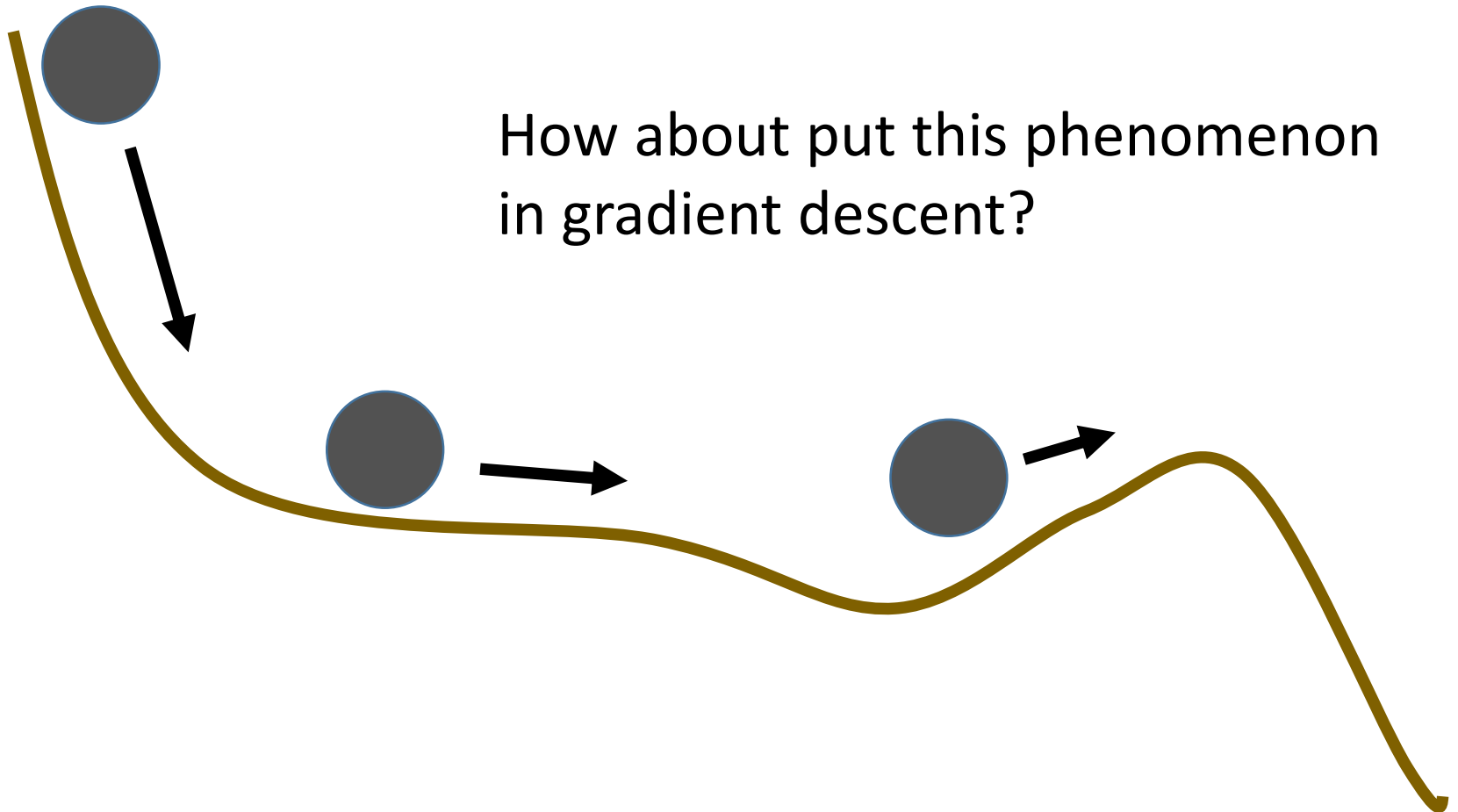

Review: Vanilla Gradient Descent

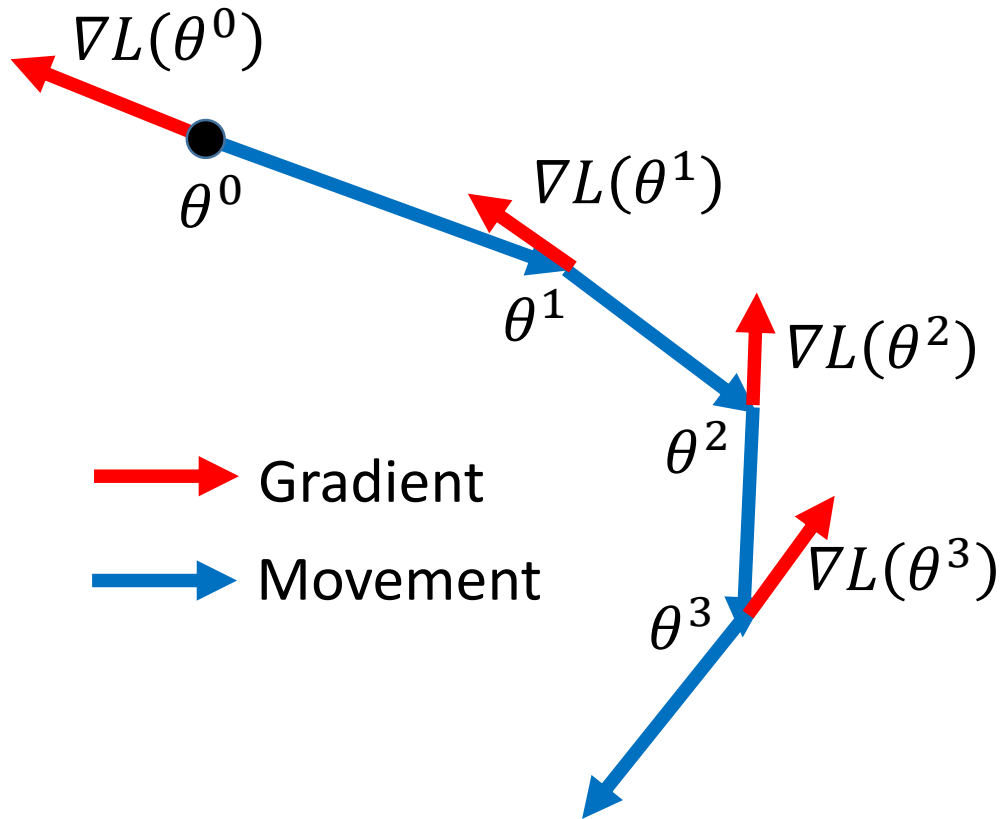

Start at position θ^0

Compute gradient at θ^0

Move to $\theta^1 = \theta^0 - \eta \nabla L(\theta^0)$

Compute gradient at θ^1

Move to $\theta^2 = \theta^1 - \eta \nabla L(\theta^1)$

⋮

Stop until $\nabla L(\theta^t) \approx 0$

Momentum

Movement: movement of last step minus gradient at present

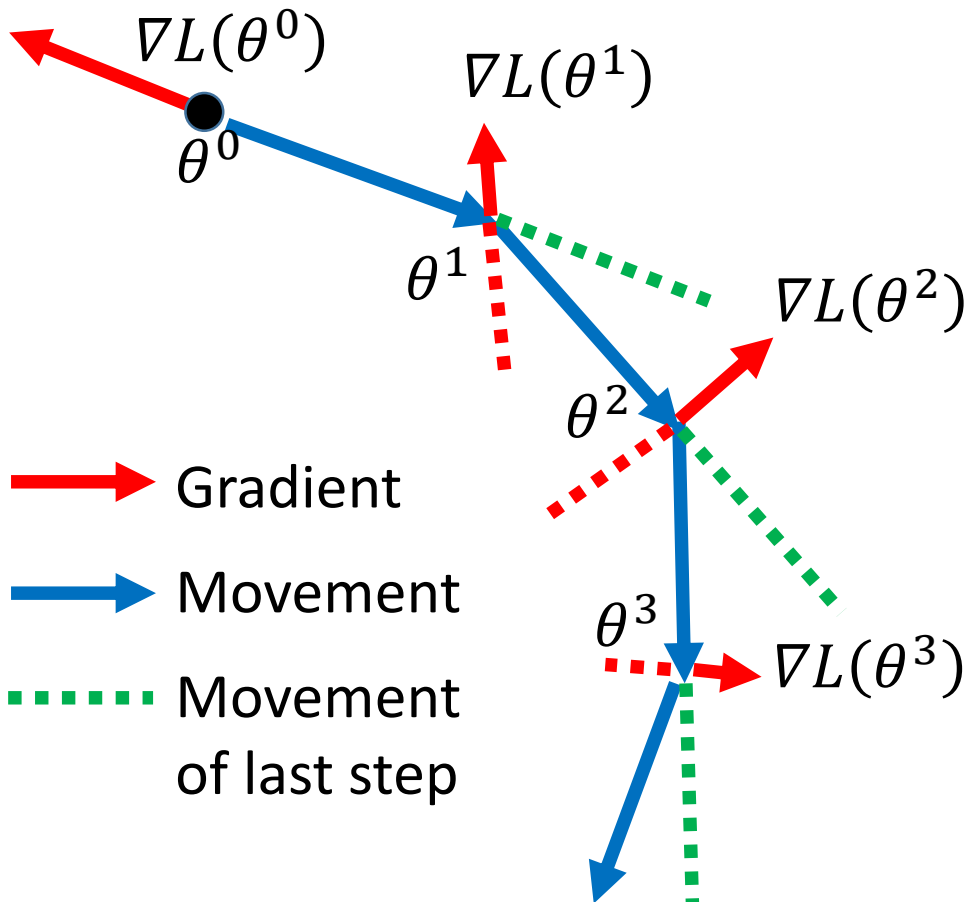

Start at point θ^0

Movement $v^0=0$

Compute gradient at θ^0

Movement $v^1 = \lambda v^0 - \eta \nabla L(\theta^0)$

Move to $\theta^1 = \theta^0 + v^1$

Compute gradient at θ^1

Movement $v^2 = \lambda v^1 - \eta \nabla L(\theta^1)$

Move to $\theta^2 = \theta^1 + v^2$

Movement not just based on gradient, but previous movement.

Momentum

Movement: movement of last step minus gradient at present

v^i is actually the weighted sum of all the previous gradient:

$$\nabla L(\theta^0), \nabla L(\theta^1), \dots \nabla L(\theta^{i-1})$$

$$v^0 = 0$$

$$v^1 = -\eta \nabla L(\theta^0)$$

$$v^2 = -\lambda \eta \nabla L(\theta^0) - \eta \nabla L(\theta^1)$$

⋮

Start at point θ^0

Movement $v^0=0$

Compute gradient at θ^0

Movement $v^1 = \lambda v^0 - \eta \nabla L(\theta^0)$

Move to $\theta^1 = \theta^0 + v^1$

Compute gradient at θ^1

Movement $v^2 = \lambda v^1 - \eta \nabla L(\theta^1)$

Move to $\theta^2 = \theta^1 + v^2$

Movement not just based on gradient, but previous movement

Momentum

Still not guarantee reaching global minima, but give some hope

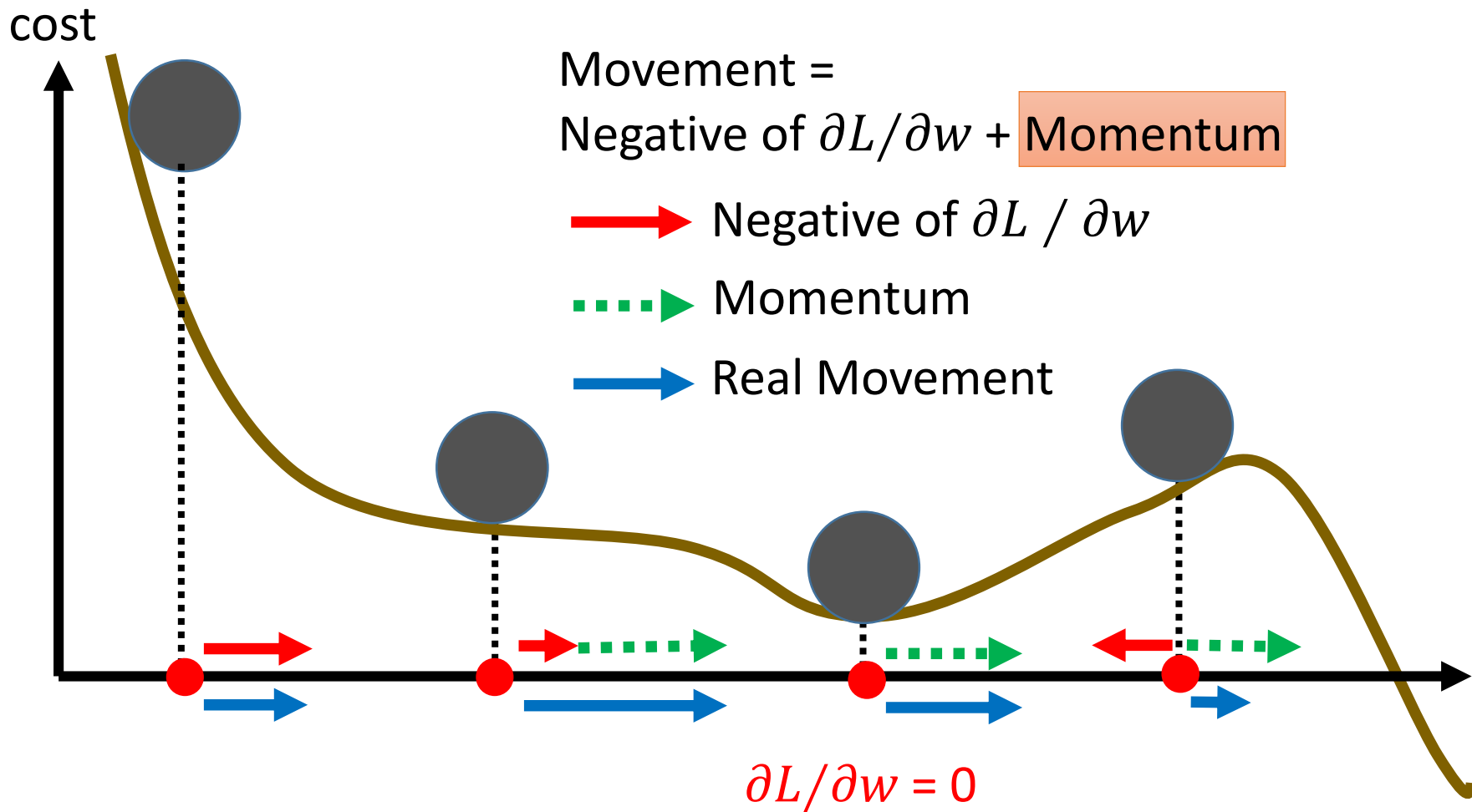

Adam

RMSProp + Momentum

Algorithm 1: *Adam*, our proposed algorithm for stochastic optimization. See section 2 for details, and for a slightly more efficient (but less clear) order of computation. g_t^2 indicates the elementwise square $g_t \odot g_t$. Good default settings for the tested machine learning problems are $\alpha = 0.001$, $\beta_1 = 0.9$, $\beta_2 = 0.999$ and $\epsilon = 10^{-8}$. All operations on vectors are element-wise. With β_1^t and β_2^t we denote β_1 and β_2 to the power t .

Require: α : Stepsize

Require: $\beta_1, \beta_2 \in [0, 1)$: Exponential decay rates for the moment estimates

Require: $f(\theta)$: Stochastic objective function with parameters θ

Require: θ_0 : Initial parameter vector

$m_0 \leftarrow 0$ (Initialize 1st moment vector) \rightarrow for momentum

$v_0 \leftarrow 0$ (Initialize 2nd moment vector) \rightarrow for RMSprop

$t \leftarrow 0$ (Initialize timestep)

while θ_t not converged **do**

$t \leftarrow t + 1$

$g_t \leftarrow \nabla_{\theta} f_t(\theta_{t-1})$ (Get gradients w.r.t. stochastic objective at timestep t)

$m_t \leftarrow \beta_1 \cdot m_{t-1} + (1 - \beta_1) \cdot g_t$ (Update biased first moment estimate)

$v_t \leftarrow \beta_2 \cdot v_{t-1} + (1 - \beta_2) \cdot g_t^2$ (Update biased second raw moment estimate)

$\hat{m}_t \leftarrow m_t / (1 - \beta_1^t)$ (Compute bias-corrected first moment estimate)

$\hat{v}_t \leftarrow v_t / (1 - \beta_2^t)$ (Compute bias-corrected second raw moment estimate)

$\theta_t \leftarrow \theta_{t-1} - \alpha \cdot \hat{m}_t / (\sqrt{\hat{v}_t} + \epsilon)$ (Update parameters)

end while

return θ_t (Resulting parameters)

Recipe of Deep Learning

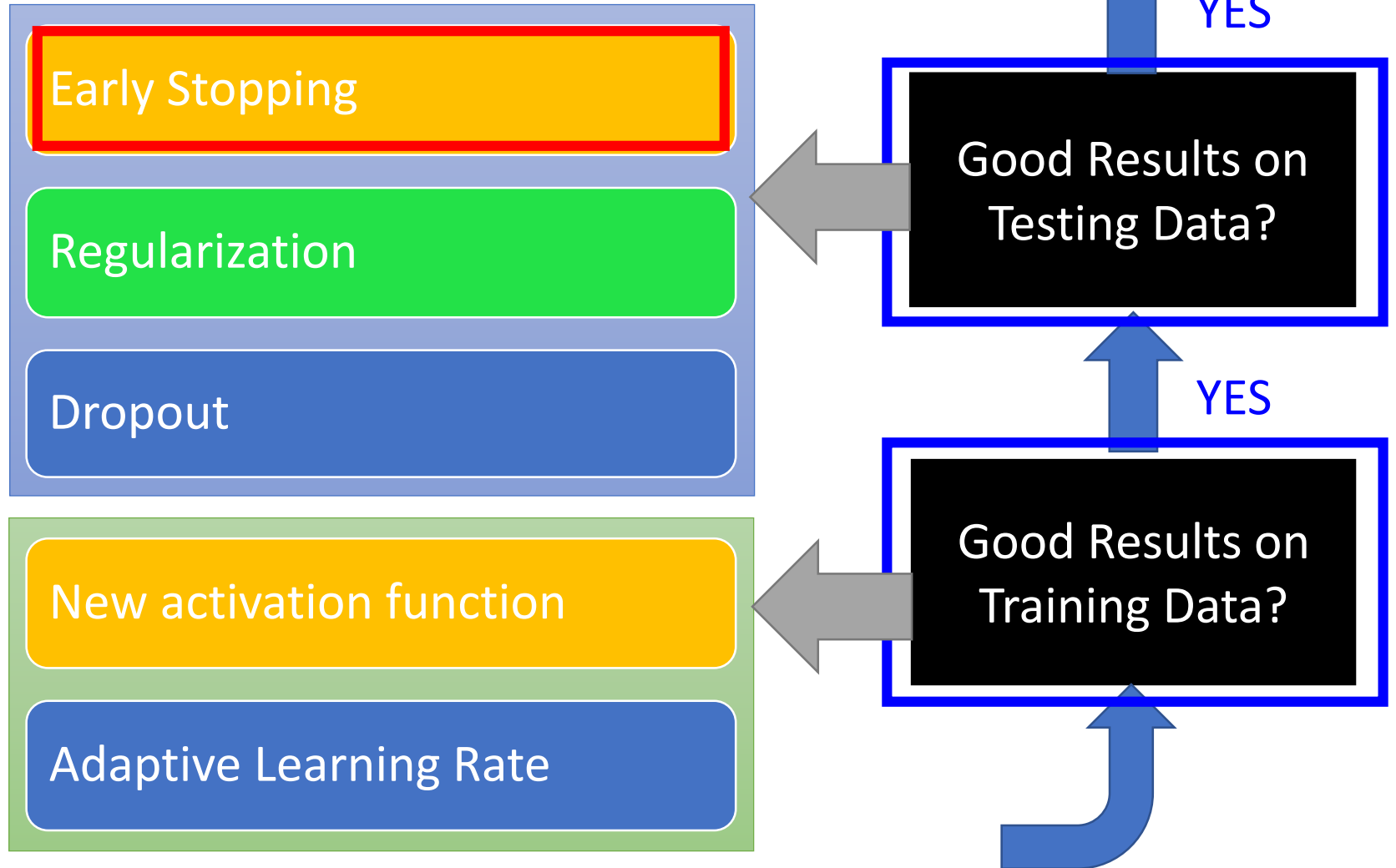

Early Stopping

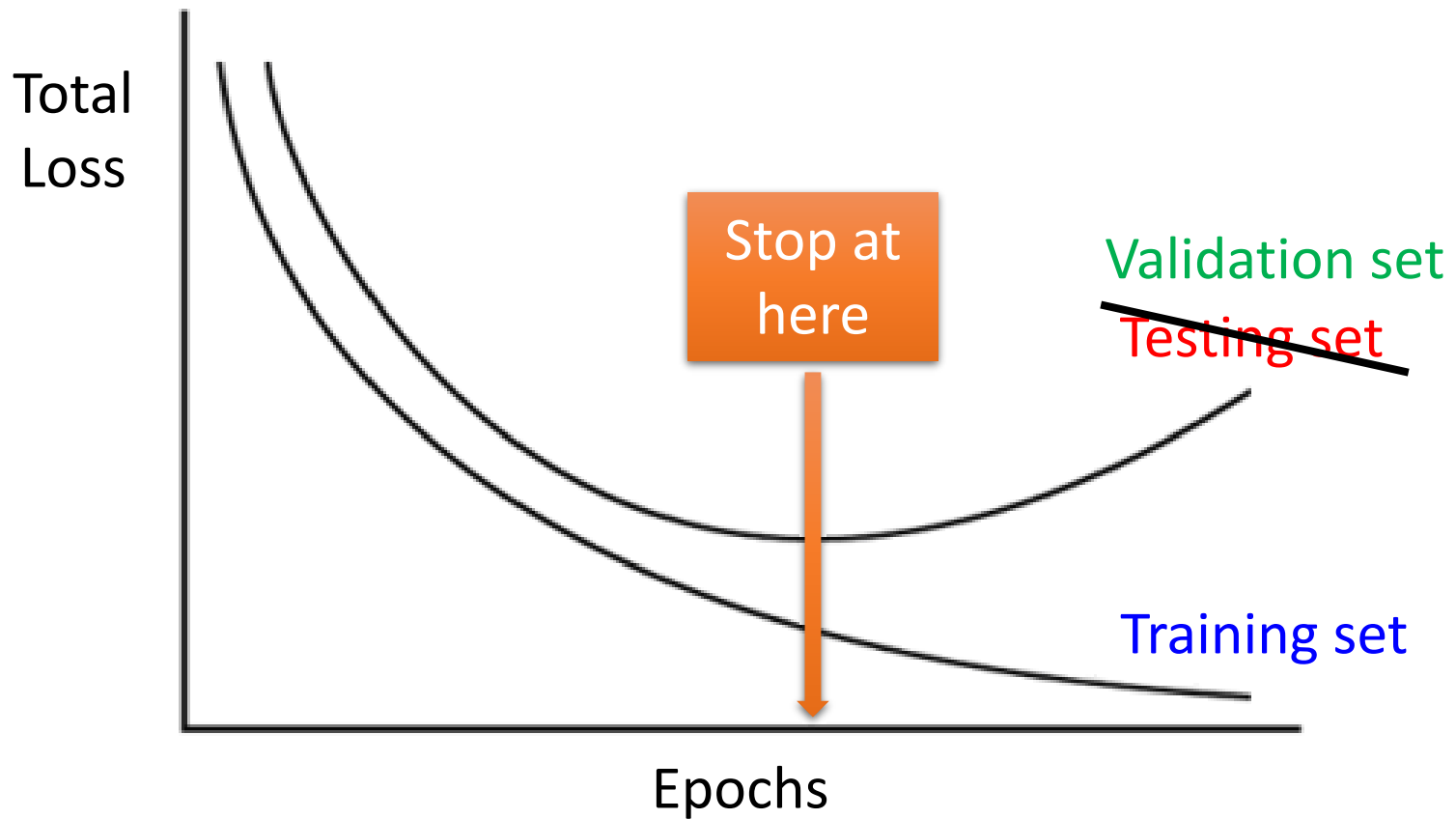

Keras: <http://keras.io/getting-started/faq/#how-can-i-interrupt-training-when-the-validation-loss-isnt-decreasing-anymore>

Recipe of Deep Learning

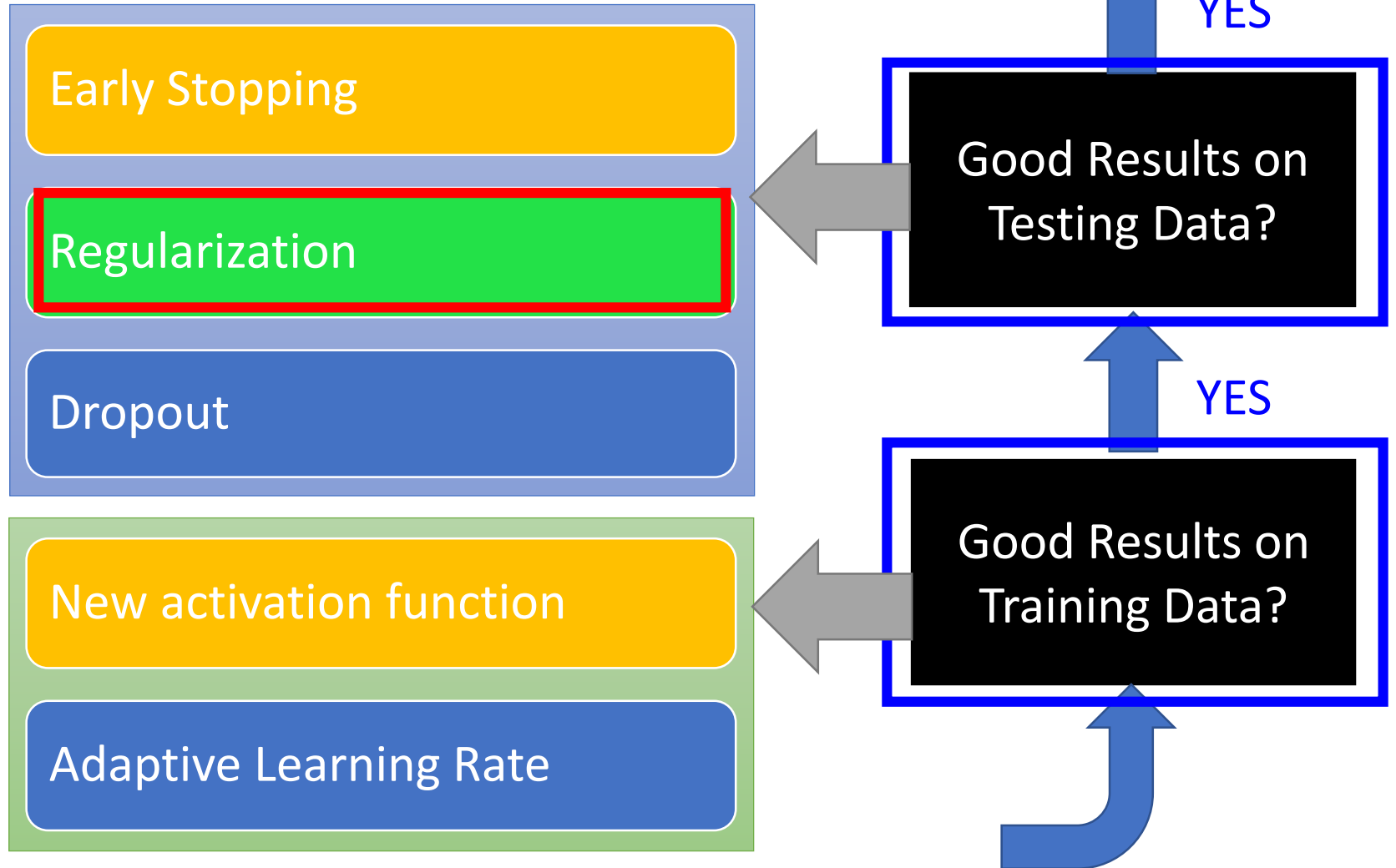

Regularization

- New loss function to be minimized
 - Find a set of weight not only minimizing original cost but also close to zero

$$L'(\theta) = \underbrace{L(\theta)} + \lambda \frac{1}{2} \underbrace{\|\theta\|_2} \rightarrow \text{Regularization term}$$

$$\theta = \{w_1, w_2, \dots\}$$

Original loss

(e.g. minimize square error, cross entropy ...)

L2 regularization:

$$\|\theta\|_2 = (w_1)^2 + (w_2)^2 + \dots$$

(usually not consider biases)

Regularization

L2 regularization:

$$\|\theta\|_2 = (w_1)^2 + (w_2)^2 + \dots$$

- New loss function to be minimized

$$L'(\theta) = L(\theta) + \lambda \frac{1}{2} \|\theta\|_2^2 \quad \text{Gradient: } \frac{\partial L'}{\partial w} = \frac{\partial L}{\partial w} + \lambda w$$

$$\text{Update: } w^{t+1} \rightarrow w^t - \eta \frac{\partial L'}{\partial w} = w^t - \eta \left(\frac{\partial L}{\partial w} + \lambda w^t \right)$$

$$= \underbrace{(1 - \eta\lambda)w^t}_{\downarrow} - \eta \underbrace{\frac{\partial L}{\partial w}}$$

Weight Decay

Closer to zero

Regularization

L1 regularization:

$$\|\theta\|_1 = |w_1| + |w_2| + \dots$$

- New loss function to be minimized

$$L'(\theta) = L(\theta) + \lambda \frac{1}{2} \|\theta\|_1 \quad \frac{\partial L'}{\partial w} = \frac{\partial L}{\partial w} + \lambda \operatorname{sgn}(w)$$

Update:

$$\begin{aligned} w^{t+1} &\rightarrow w^t - \eta \frac{\partial L'}{\partial w} = w^t - \eta \left(\frac{\partial L}{\partial w} + \lambda \operatorname{sgn}(w^t) \right) \\ &= w^t - \eta \frac{\partial L}{\partial w} - \underline{\eta \lambda \operatorname{sgn}(w^t)} \quad \text{Always delete} \\ &= (1 - \eta \lambda) w^t - \eta \frac{\partial L}{\partial w} \quad \text{..... L2} \end{aligned}$$

Regularization - Weight Decay

- Our brain prunes out the useless link between neurons.

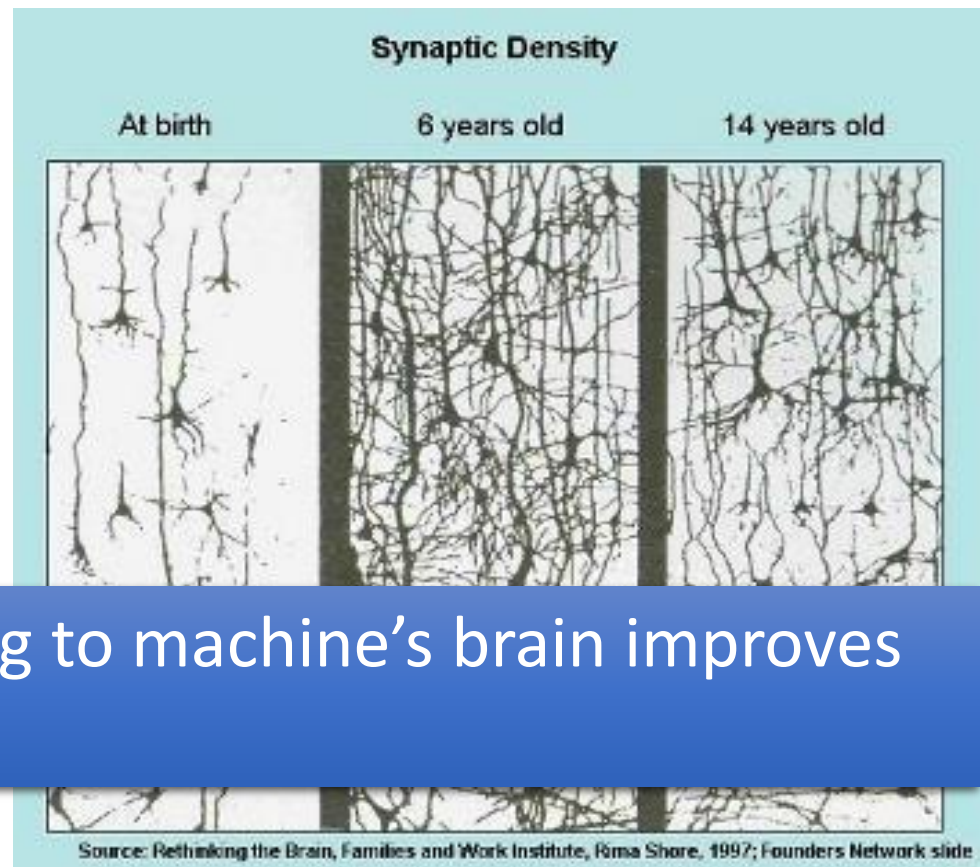

Doing the same thing to machine's brain improves the performance.

Recipe of Deep Learning

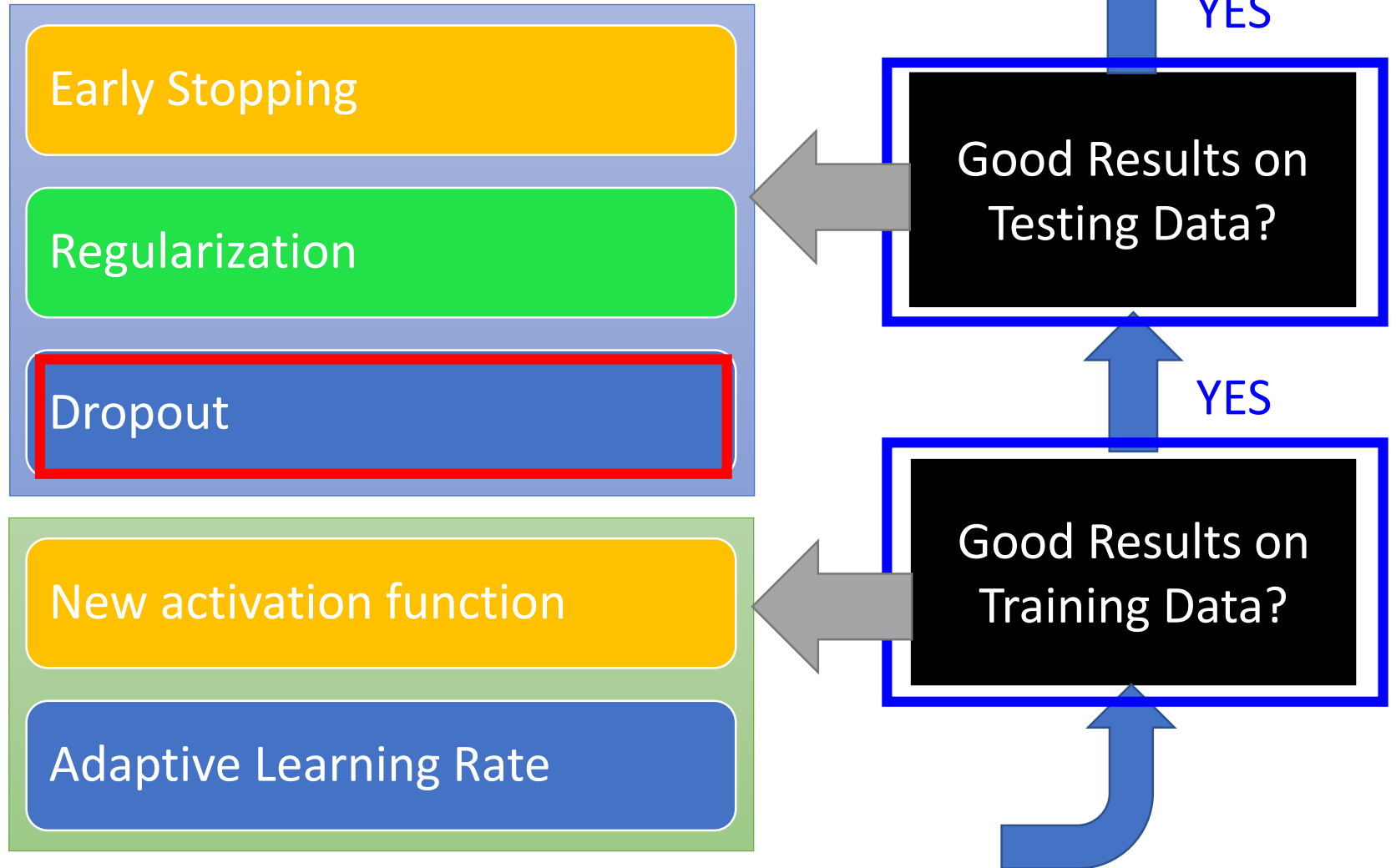

Dropout

Training:

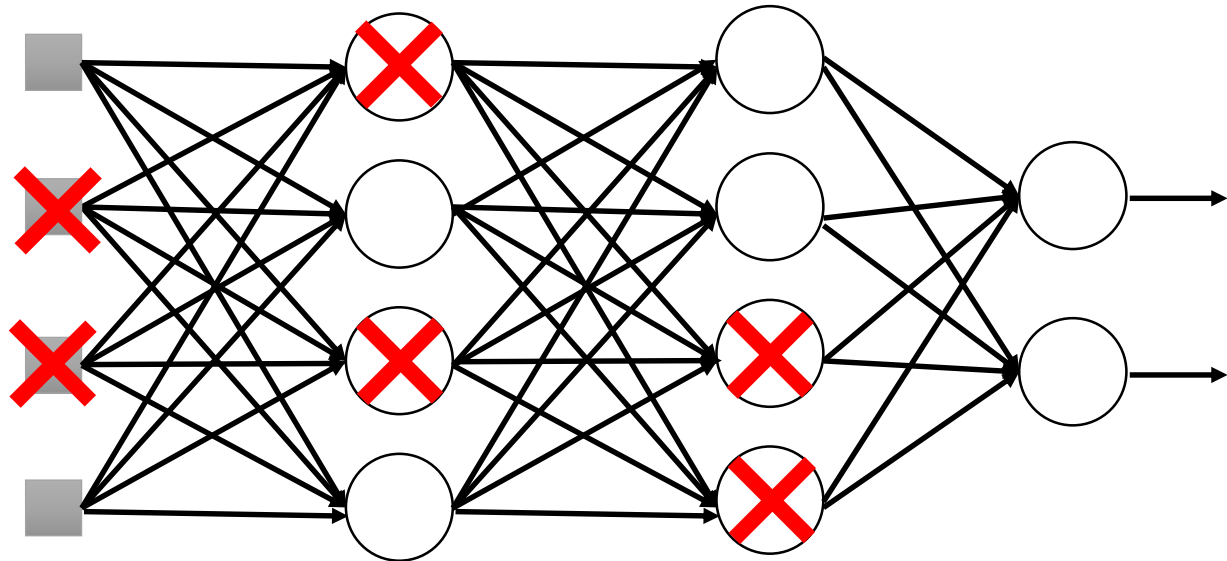

- **Each time before updating the parameters**
 - Each neuron has $p\%$ to dropout

Dropout

Training:

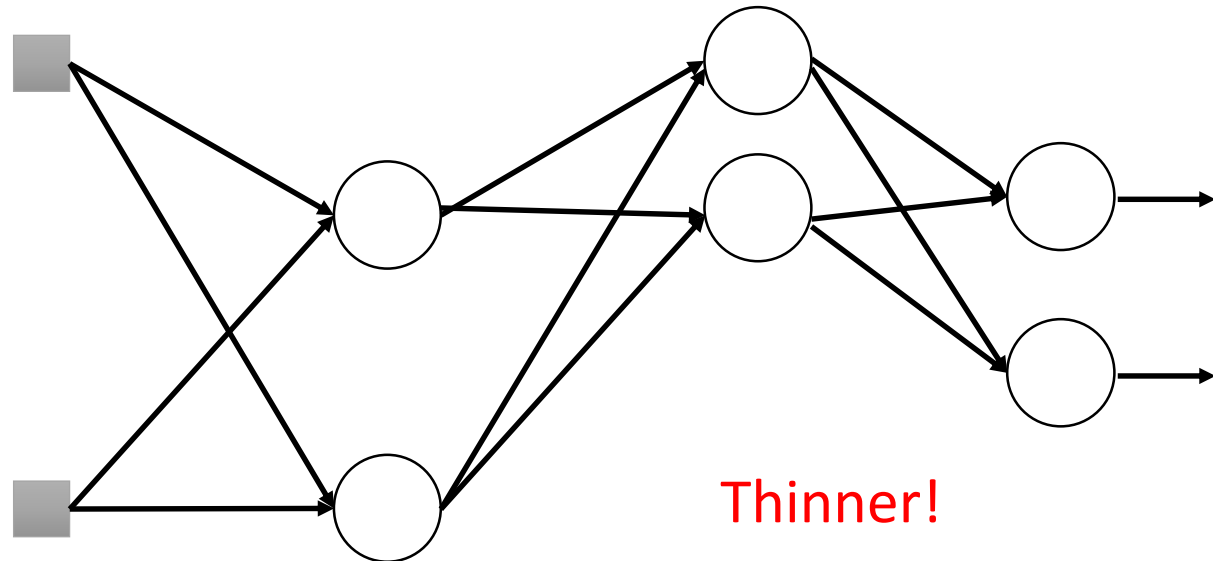

- **Each time before updating the parameters**
 - Each neuron has $p\%$ to dropout
 - ➔ **The structure of the network is changed.**
 - Using the new network for training

For each mini-batch, we resample the dropout neurons

Dropout

Testing:

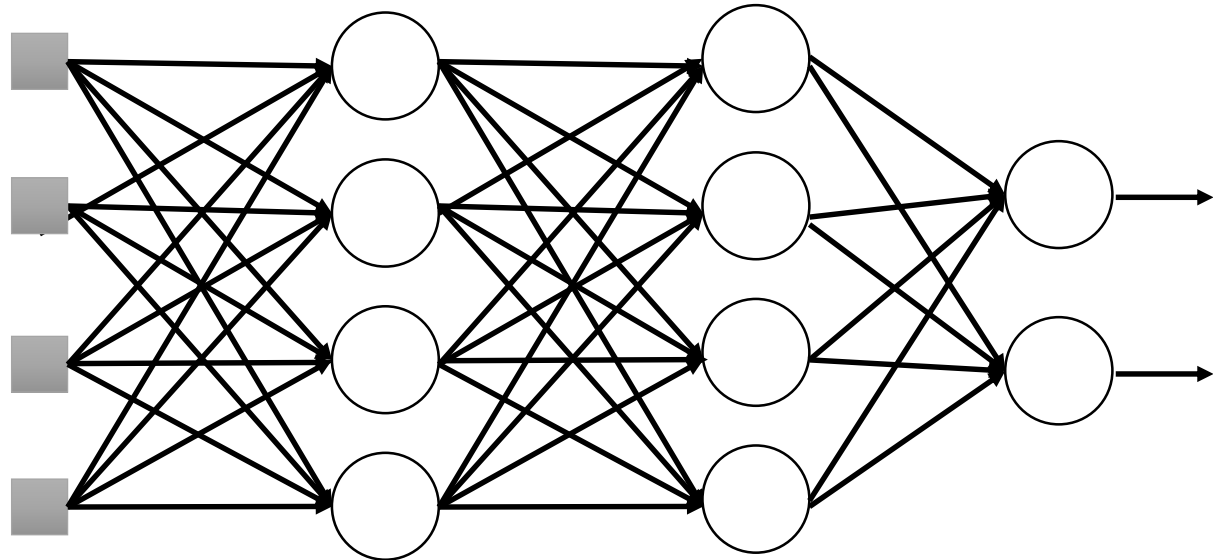

➤ No dropout

- If the dropout rate at training is $p\%$, all the weights times $1-p\%$
- Assume that the dropout rate is 50%. If a weight $w = 1$ by training, set $w = 0.5$ for testing.

Dropout

- Intuitive Reason

Training

Dropout (腳上綁重物)



Testing

No dropout
(拿下重物後就變很強)



Dropout - Intuitive Reason

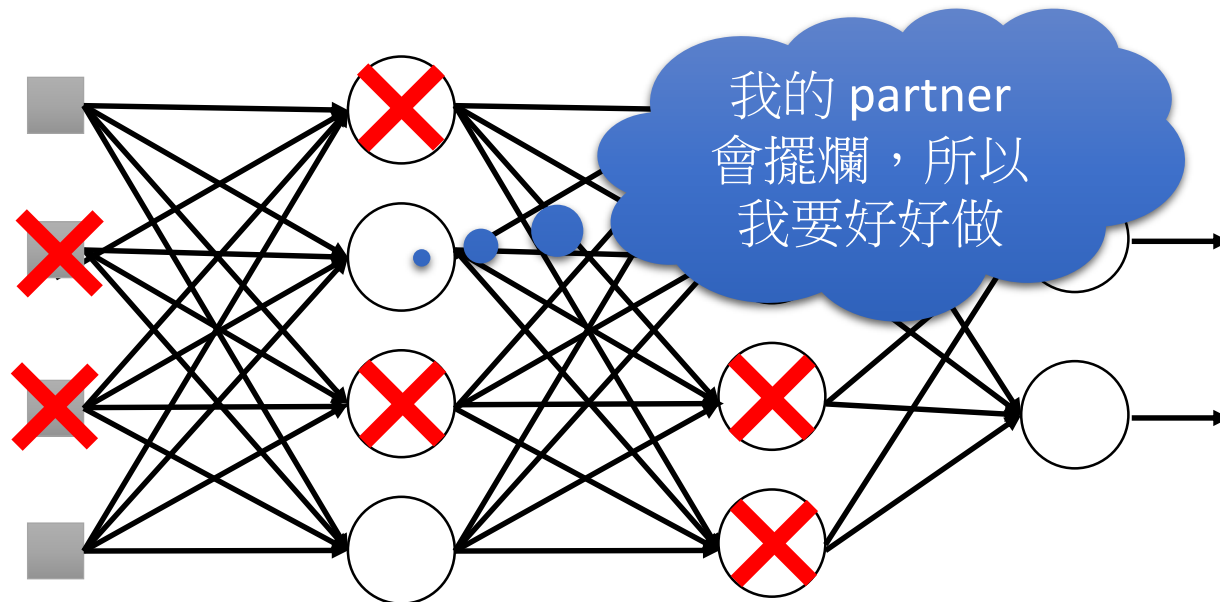

- When teams up, if everyone expect the partner will do the work, nothing will be done finally.
- However, if you know your partner will dropout, you will do better.
- When testing, no one dropout actually, so obtaining good results eventually.

Dropout - Intuitive Reason

- Why the weights should multiply (1-p)% (dropout rate) when testing?

Training of Dropout

Assume dropout rate is 50%

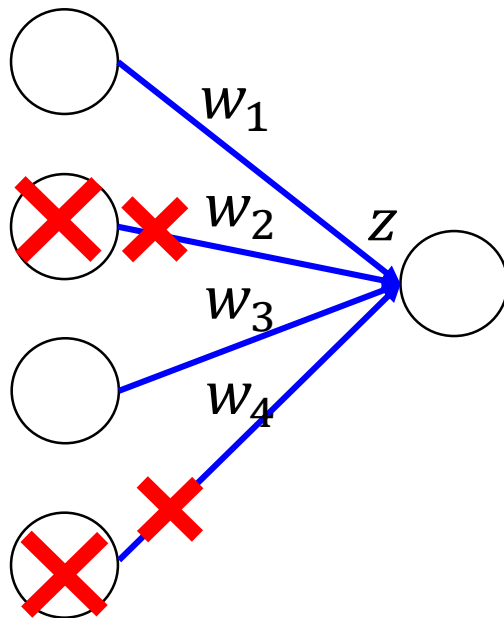

Testing of Dropout

No dropout

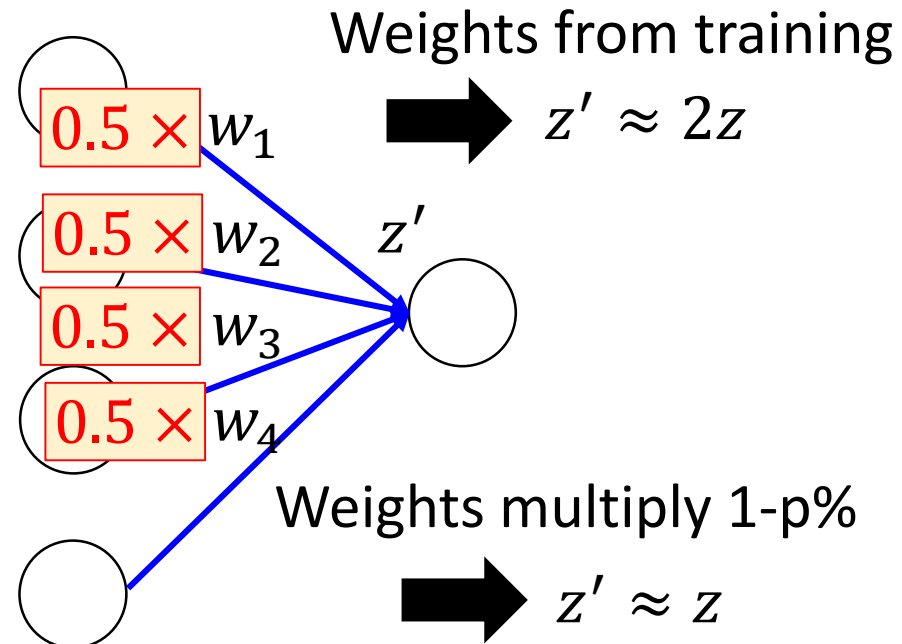

Weights multiply 1-p%

$z' \approx z$

Dropout is a kind of ensemble.

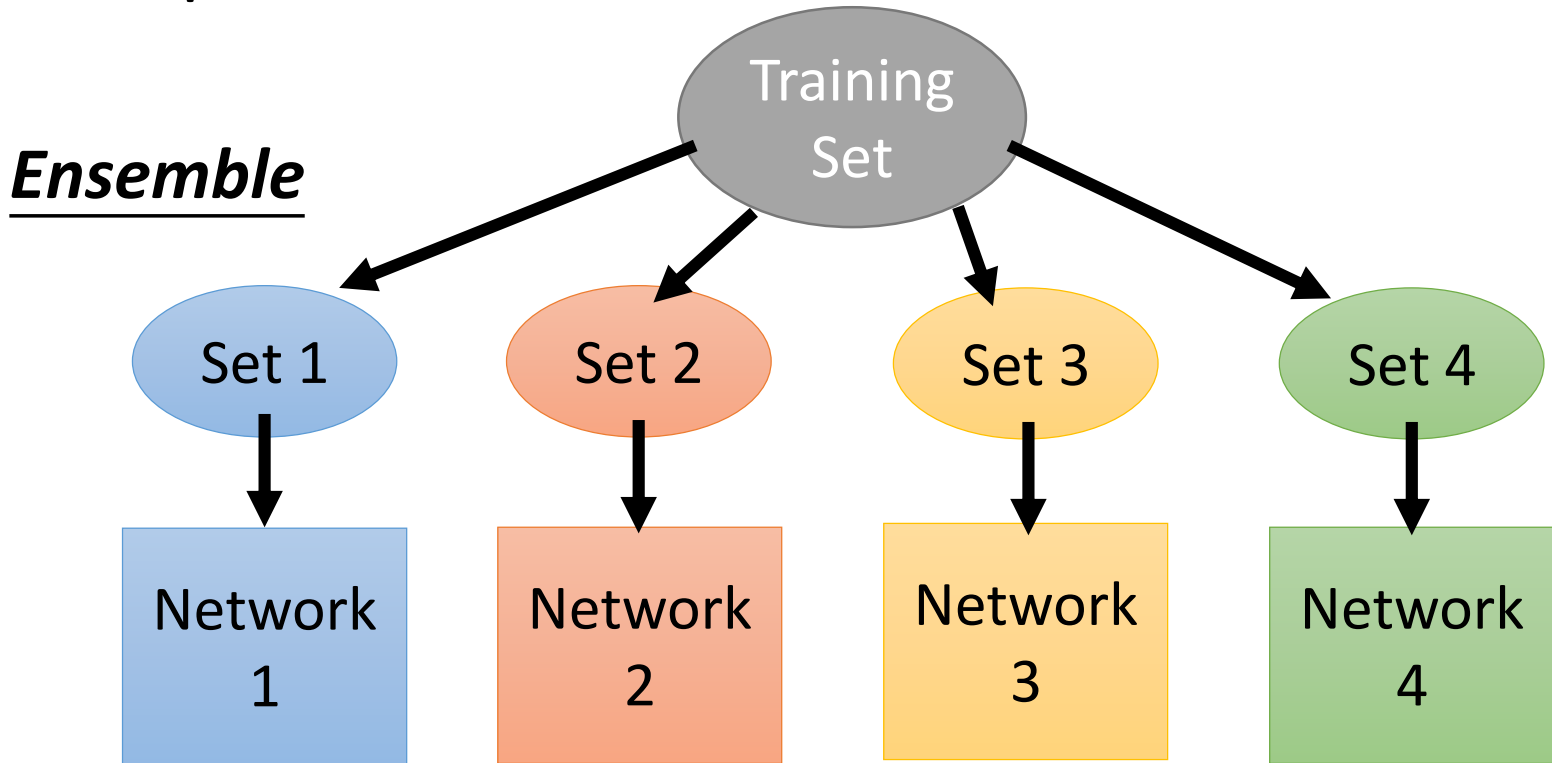

Train a bunch of networks with different structures

Dropout is a kind of ensemble.

Ensemble

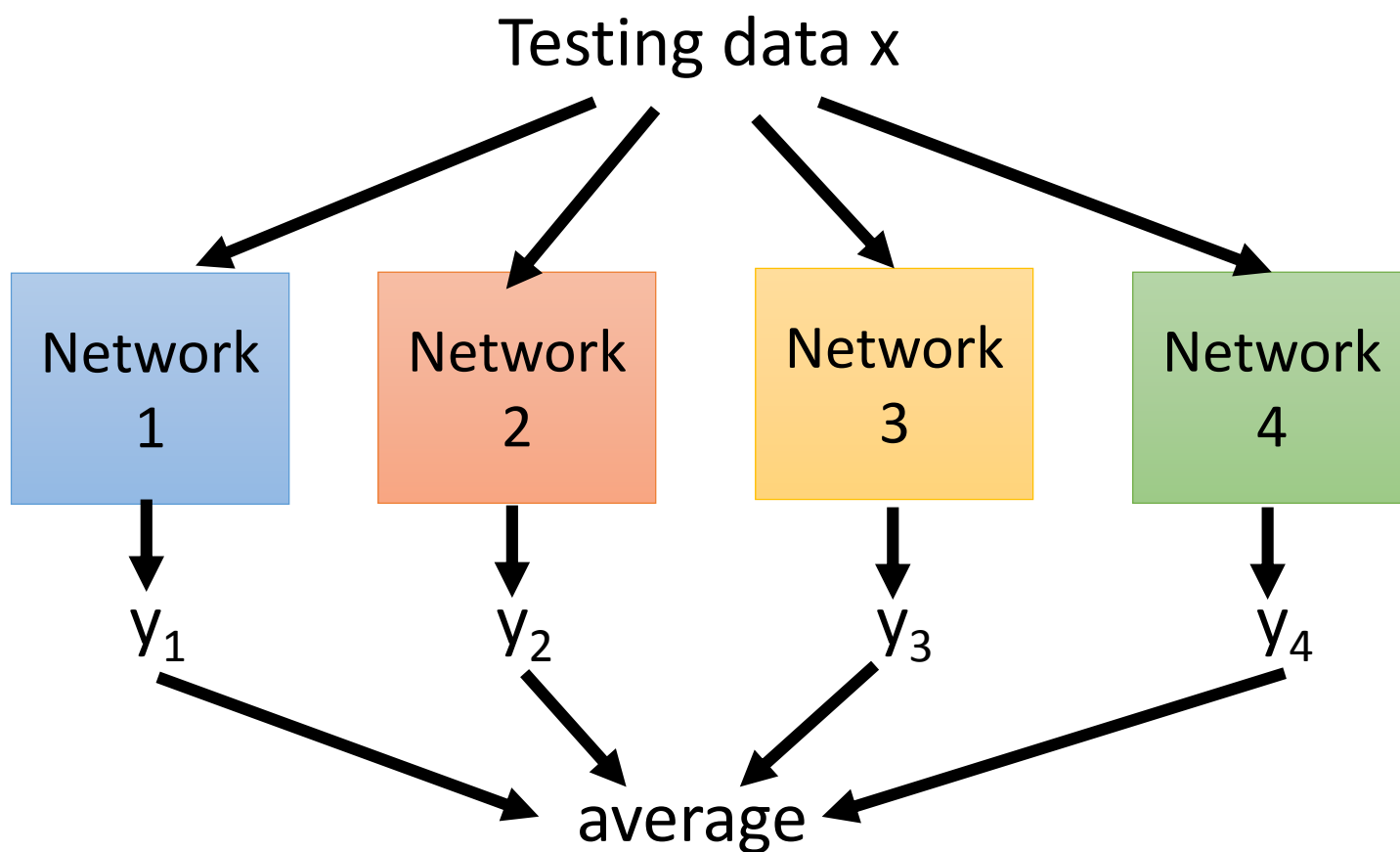

Dropout is a kind of ensemble.

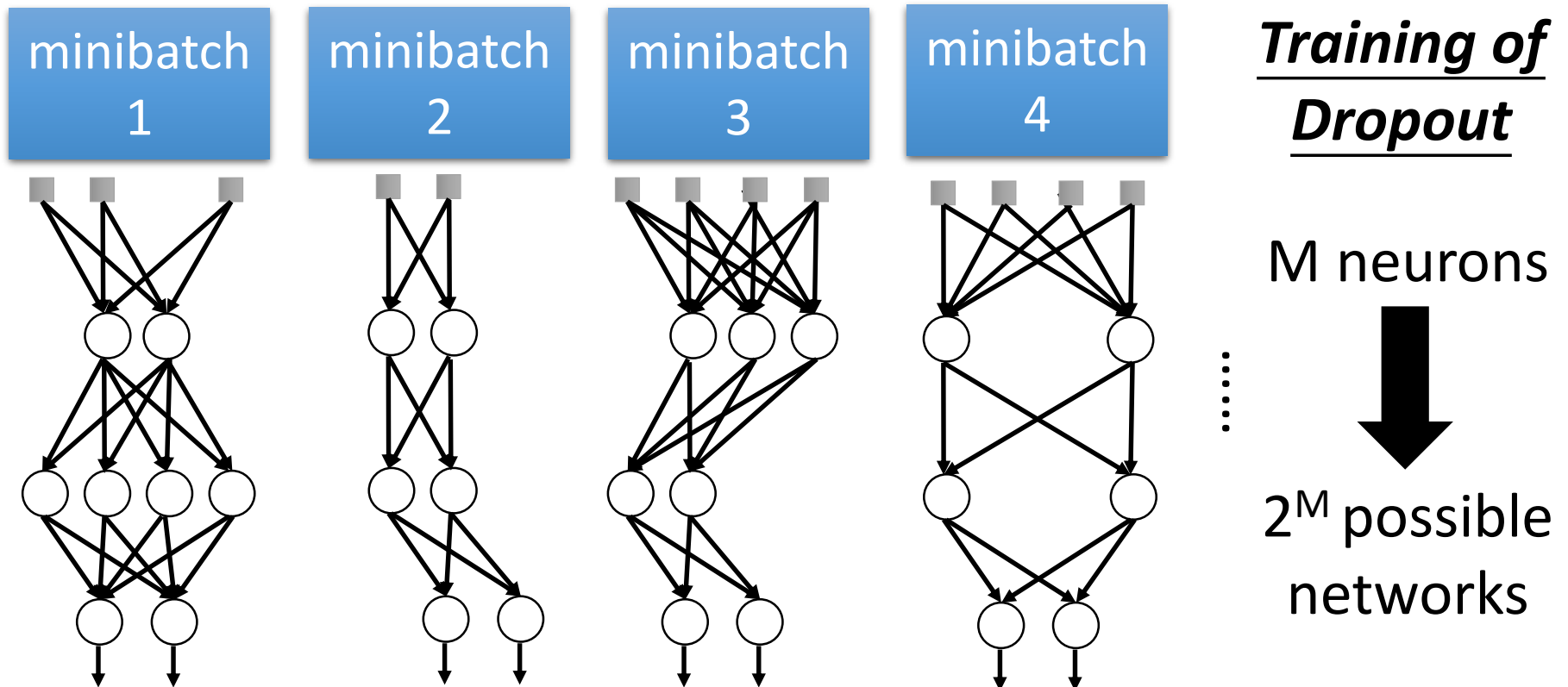

- Using one mini-batch to train one network
- Some parameters in the network are shared

Dropout is a kind of ensemble.

Testing of Dropout

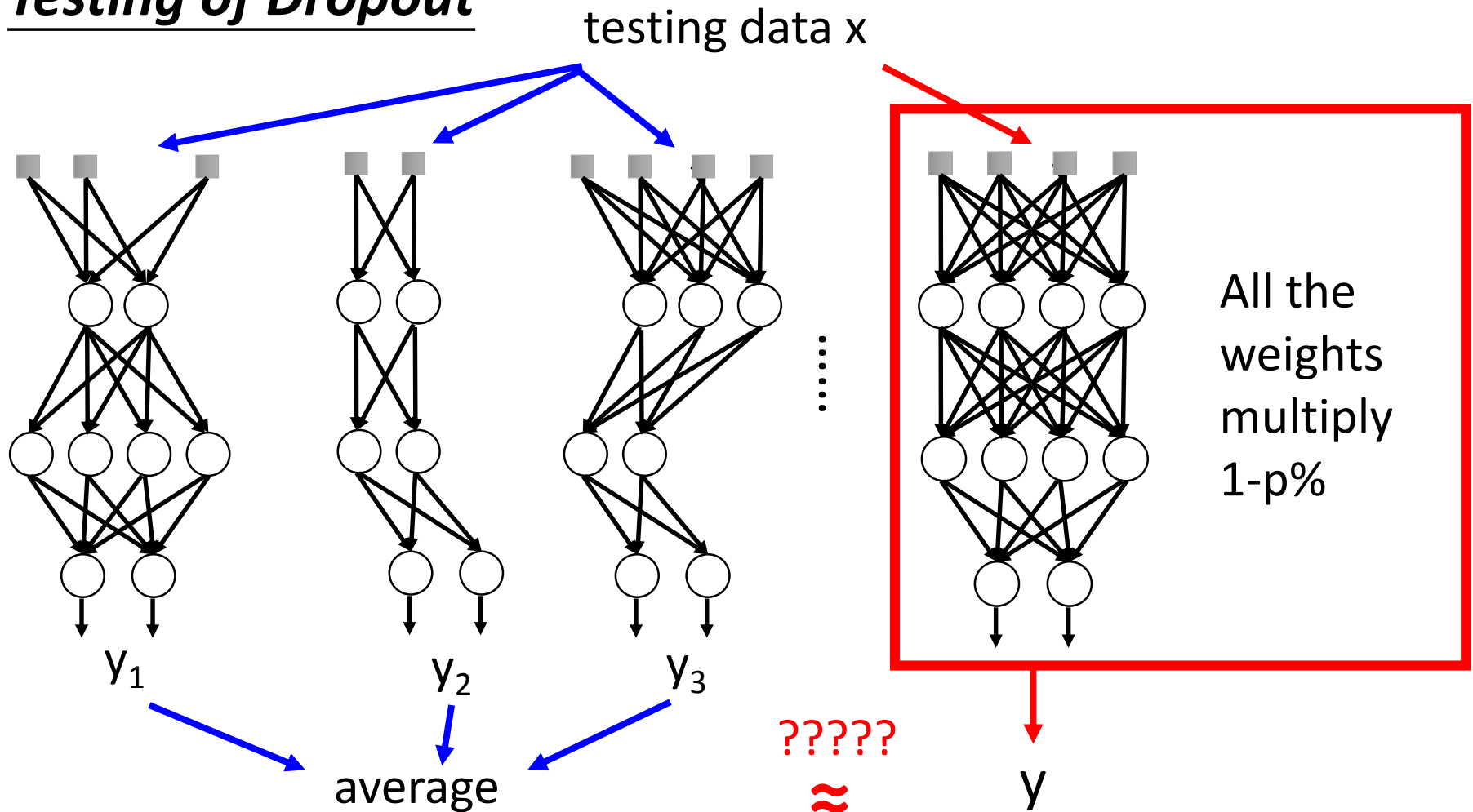

Testing of Dropout

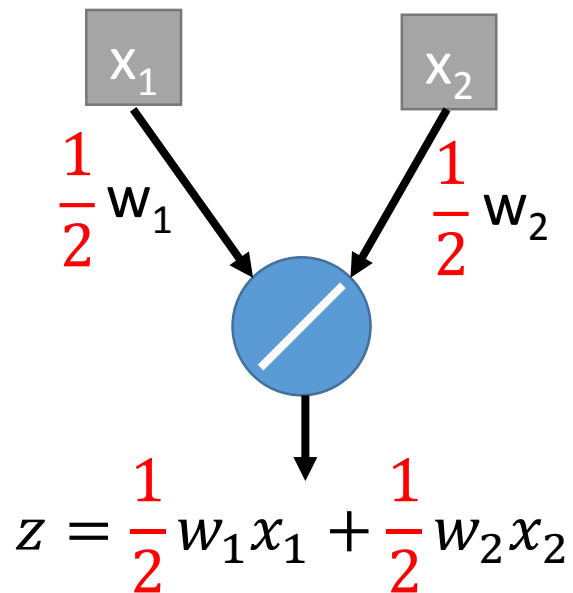
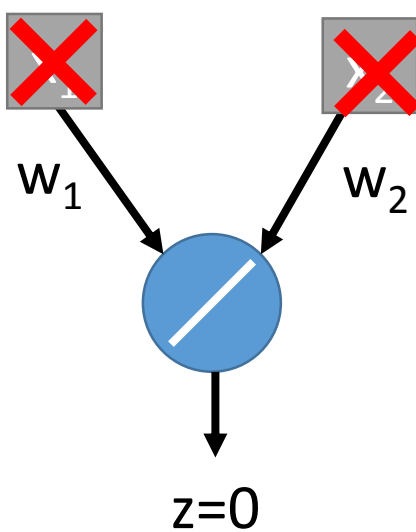
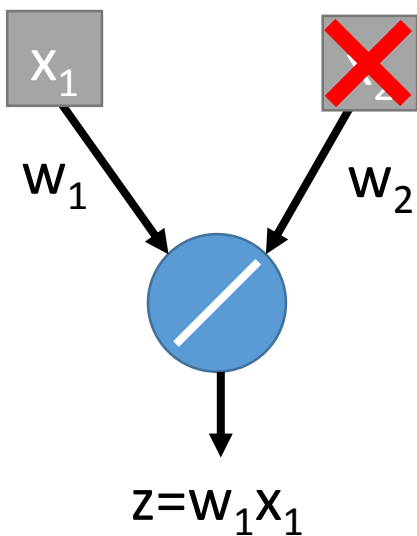
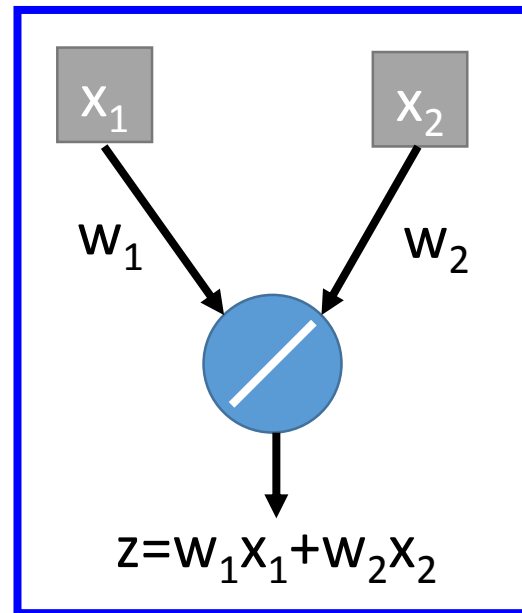
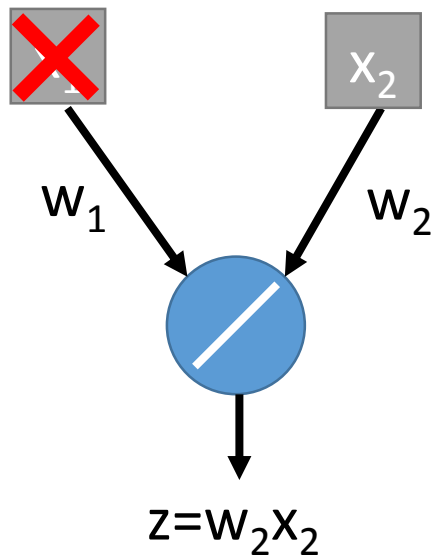
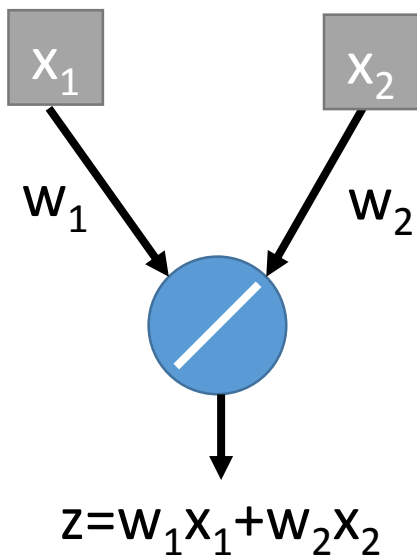

Recipe of Deep Learning

